

BES-560T

600 Watt

- ✓ -48VDC input (-36...-72 VDC)
- ✓ Designed for applications in industry, telecommunication and transportation
- ✓ TÜV and UL approved
- ✓ EN/UL 62368-1 certified
- ✓ High efficiency >80 %
- ✓ Strong 12 V rail (45 A) for high performance graphic applications
- ✓ No minimum load required
- ✓ Ball beared and temperature controlled fan with tachometer signal for monitoring



DC input

Technical data	
Input voltage	-48VDC (-36...-72V)
Input current	16A max. at -48VDC
Inrush current	<50A (-48VDC / 25 °C)
Efficiency	>80% at full load
Hold up time	Appr. 1 ms
Power-Good-Signal	Switch on delay 100...500 ms
Protection	Short circuit protection: Switch off with auto recovery Inverse polarity protection input: existing Overvoltage protection: +3.3V (+3.6...+4.3V), +5V (+5.6...+6.5V), +12V (+13.2...+15V), switch off
Safety / EMC	CE, EN/UL62368-1
Temperature	Operating: 0...+70°C, startable from -20°C / Storage: -20...+80°C
Derating	+40...+70°C, 1% / °C
MTBF	141 236h according to MIL-HDBK-217F at +25 °C with fan
Max. operation altitude	3100 m
Humidity	Operating: 10...85% RH, non-condensing / Storage: 10...90% RH, non-condensing
LED	Standby: off / PSU on: green
Dimensions (WxDxH)	150 x 140 x 86 mm ±0.5 mm
Weight (net)	1.65 kg

Article No.	Output voltage	Output current min	Output current max	Load regulation	Line regulation	Cross regulation	Ripple & Noise
BES-560T	+3.3V	0 A	25 A	±5 %	±1 %	±5 %	±50 mV
	+5V	0 A	25 A	±5 %	±1 %	±5 %	±50 mV
	+12V	0 A	45 A	±5 %	±1 %	±5 %	±120 mV
	-12V	0A	0.8A	±10%	±1 %	±5 %	±120 mV
	+5V _{sb}	0A	3.5A	±5 %	±1 %	±5 %	±50 mV

Max. output power is 600W, combined max. output power at +3.3V and +5V is 40A. Ripple and Noise was measured by a 20MHz bandwidth limited oscilloscope with connected 220µF electrolytic capacitor and 100nF ceramic capacitor at each output.

As a power component this PSU is for assembly purposes only and must not be operated in unassembled condition. The final assembly has to comply with the valid EMC and safety standards.

Drawing BES-560T

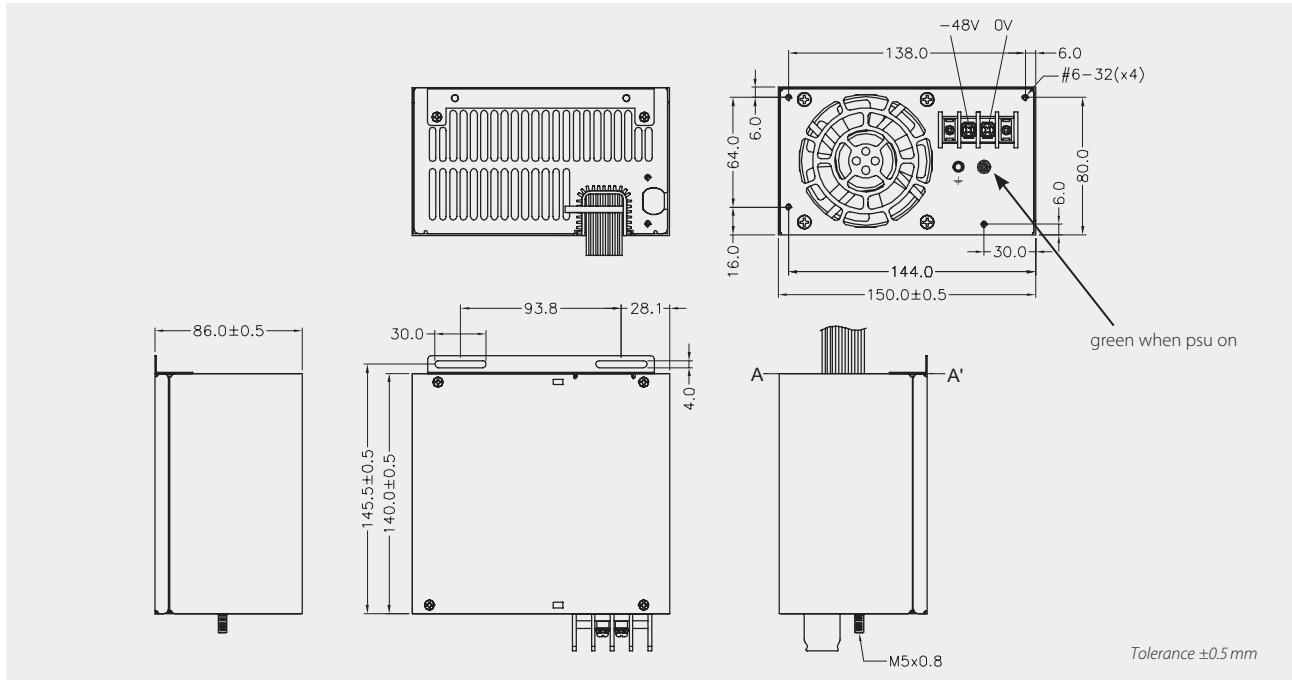

Cable harness BES-560T

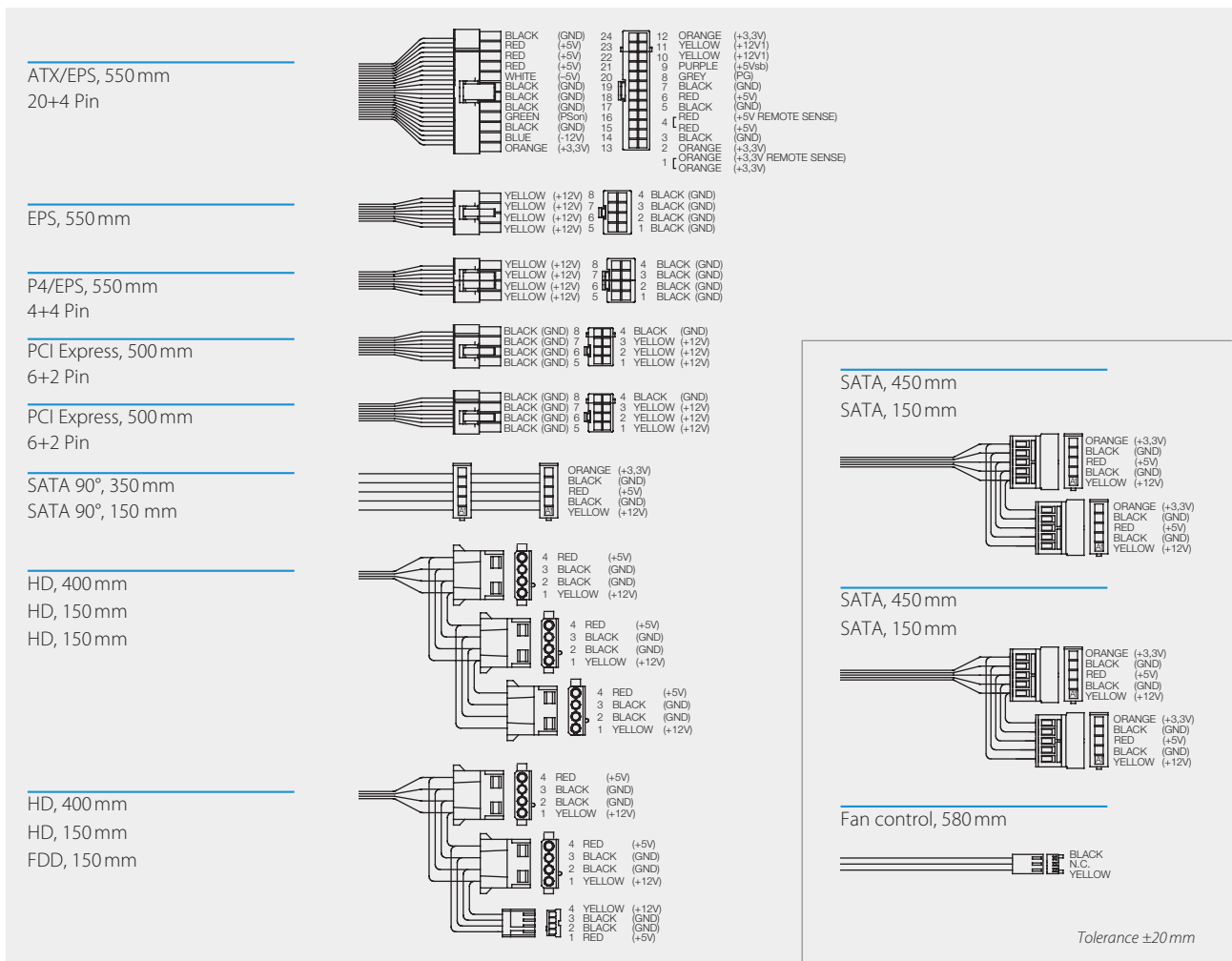

Specification is subject to change without notice. Errors excepted. Status as at: 21.04.2021