

# AFL4-12-ADL

## IEI 轻工业平板电脑

搭载第十二代英特尔® Alder Lake-P 平台



**ieI** 威强电工业电脑  
IEI Integration Corp.  
[WWW.IEIWORLD.COM.CN](http://WWW.IEIWORLD.COM.CN)



# AFL4-12-ADL

搭载英特尔®第十二代 Alder Lake-P 板载处理器, 8GB 板载内存, 2 x 2.5GbE 高速网口, 2 x M.2 M key 扩展插槽, 支持 WiFi6E和蓝牙5.2, 具有防眩光与抗紫外的10点电容式触控屏。

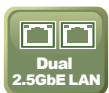

## 英特尔®第十二代CPU

搭载英特尔®第十二代 Alder Lake-P处理器, 颠覆性的混合架构, 更小机身, 更高性能

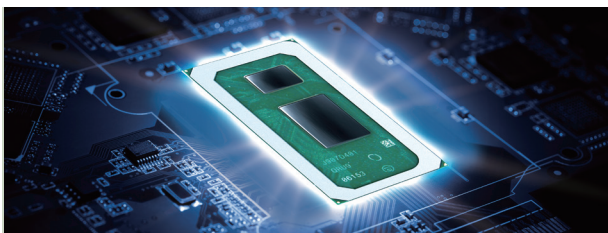

## 全速M.2 扩展

两个M.2 M key 支持2242及2280规格, PCIe Gen4 x 4 全速信号, 更大带宽, 更快速度

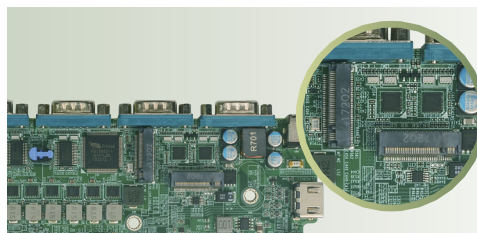

## 防眩光与抗紫外的电容触控屏

让你在户外或强光下不受反射影响, 画面清晰可见, 户外长时间使用不异变, 支持10点触控



## 支持手套和湿手操作

全新的电容触控屏, 让你在戴手套时依然顺畅操作, 屏上有水或湿手时也可精准点击



## 丰富的I/O接口

具有4串5U的丰富配置, 其中两个RS232, 两个RS-232/422/485, 4个USB 3.2, 一个USB 2.0, 轻松应对各种应用场景



## 支持WiFi6E和蓝牙5.2

更强的WiFi6E网络, 同时支持2.4GHz/5GHz及6GHz, 更大带宽, 更低时延, 蓝牙5.2连接更稳定, 功耗更低



# AFL4-12-ADL IO布局

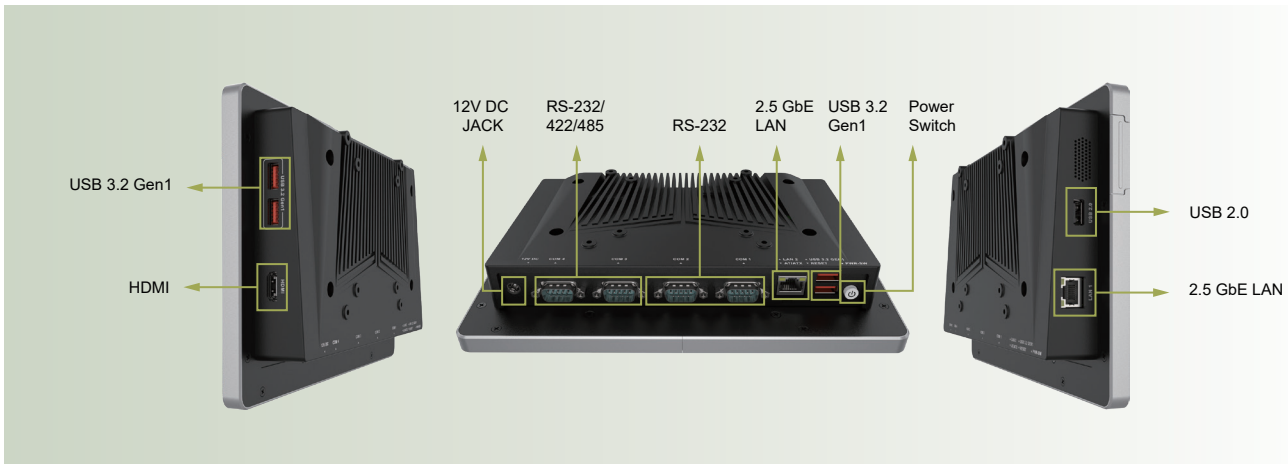

## AFL4-12-ADL Block Diagram

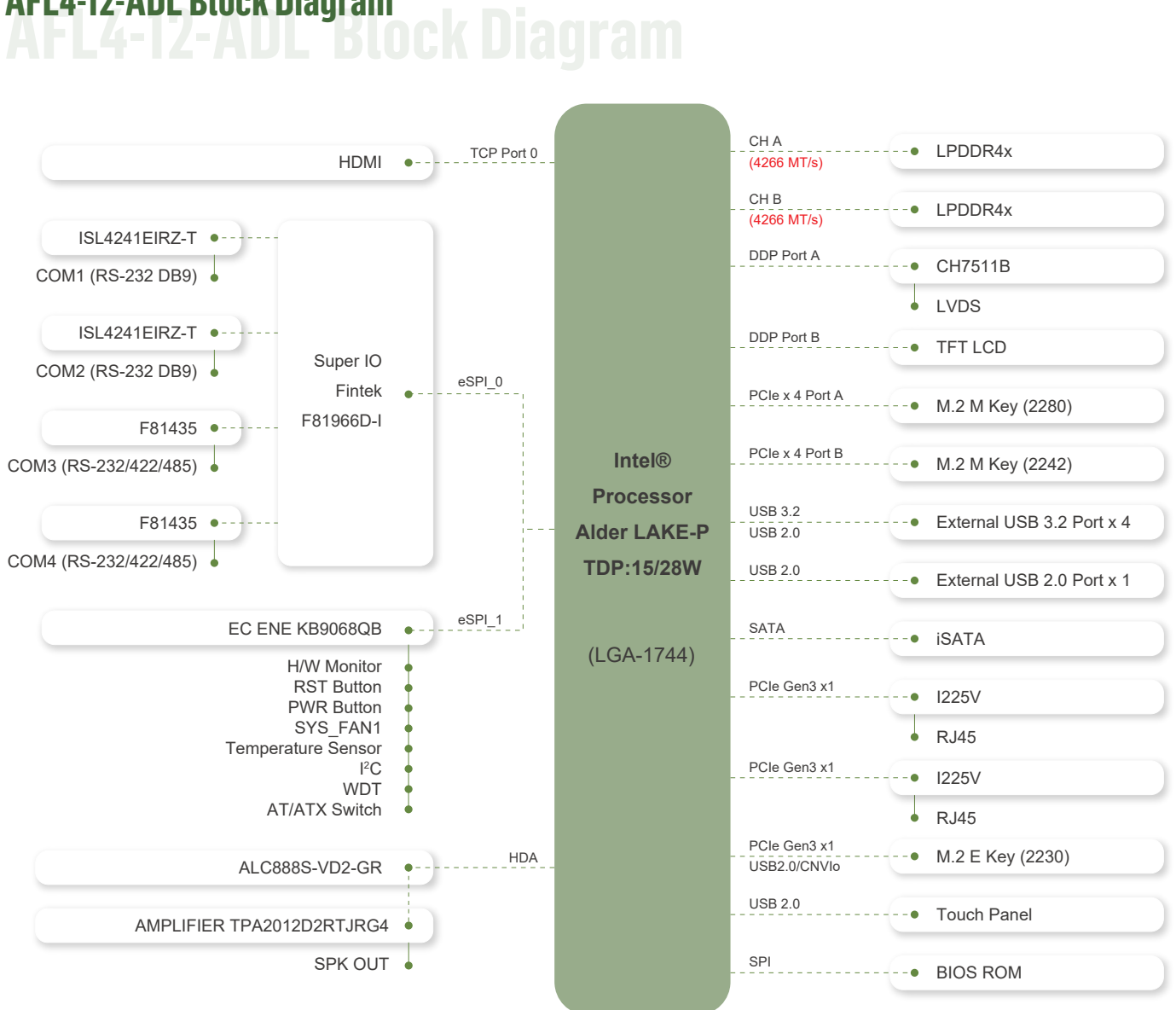

## 尺寸 Dimensions

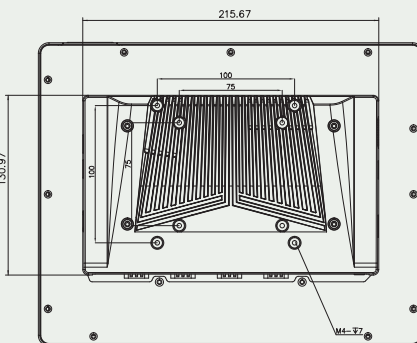
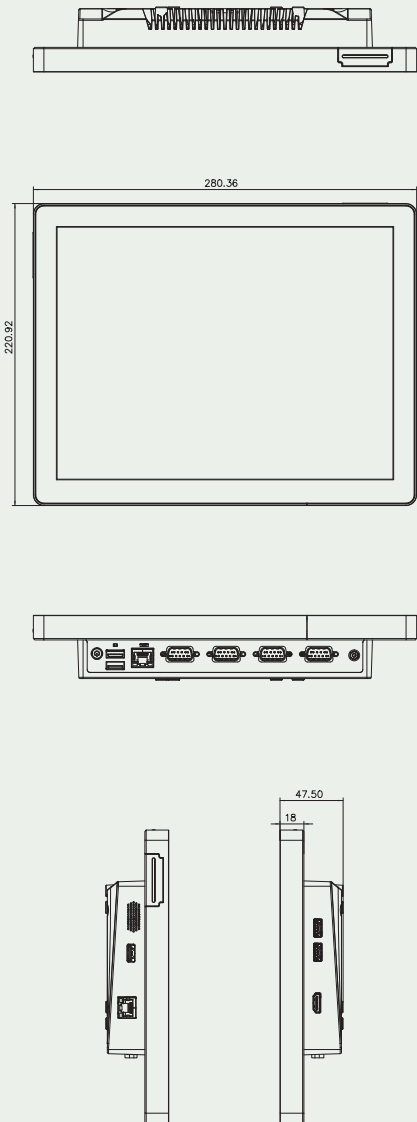

## 规格 Specifications

Model		AFL4-12-ADL
LCD	Size	12.1"
	Resolution	1024 x 768 (4:3)
	Brightness (cd/m <sup>2</sup> )	500
	Contrast Ratio	700:1
	Viewing Angle (H-V)	160°/140°
Touch	Backlight MTBF	50000 hours
	Touch Screen	PCAP with USB interface (anti-UV/AR coating)
Mainboard	Touch Controller	EETI EXC 81 Series
	SOC	12th Generation Intel® Alder Lake-P Core™ i7/i5/i3/Celeron® Processor
Storage	RAM	Dual channel On board LPDDR4X 8G
	Ethernet	LAN1: Intel® I225 + LAN2: Intel® I225
	Audio Codec	Realtek ALC888S
I/O Ports & Switch	M.2	1 x M.2 M key 2242 (PCIe Gen4 x 4) 1 x M.2 M key 2280 (PCIe Gen4 x 4)
	COM Port	2 x RS-232 by DB9 2 x RS-422/RS485 by DB9
I/O Ports & Switch	LAN Port	2 x 2.5GbE LAN
	USB Port	2 x USB 3.2 Gen1 3 x USB 2.0
I/O Ports & Switch	Display Port	1 x HDMI output
	Power in	1 x 12V DC Jack
I/O Ports & Switch	Switch	1 x Power button 1 x Reset button 1 x Clear CMOS button 1 x AT/ATX switch
	Audio	AMP 1.2W (internal speaker)
	Wireless & Bluetooth	IEEE 802.11 a/b/g/n/ax, Bluetooth V5.2 1 x M.2 2230 A Key Slot (PCIe + USB signal)
	Physical	Construction Front Panel
Mounting		Wall, Rack, Stand, ARM, VESA 75mm x 75mm
Color		Silver + Black
Environment	Operating Temperature (°C) (Ambient with air flow)	-20 ~ 50
	Storage Temperature (°C)	-20 ~ 60
	Humidity	10% to 95% (non-condensing)
	IP Level	Front panel IP65
	Safety&EMC	CE/EMC , FCC , RED (Class A)
Power	Thermal Solution	Fanless
	Power Requirement	12V
Power	ErP	ErP 2009/125/EC

## 包装清单 Packing List

1 x Power Cord	1 x Power Adapter
1 x QIG	

## 订购信息 Ordering Information

AFL4-12-ADL-P-i7/ W/8G-R10	12.1" 500cd/m <sup>2</sup> 1024x768 Fanless Panel PC with 12th Generation Intel® Core™ i7 on-board Processor,TDP 15W,8GB LPDDR4 on-board, without WiFi&Bluetooth module, PCAP touch,12V DC,R10
AFL4-12-ADL-P-i5/ W/8G-R10	12.1" 500cd/m <sup>2</sup> 1024x768 Fanless Panel PC with 12th Generation Intel® Core™ i5 on-board Processor,TDP 15W,8GB LPDDR4 on-board, without WiFi&Bluetooth module, PCAP touch,12V DC,R10
AFL4-12-ADL-P-i3/ W/8G-R10	12.1" 500cd/m <sup>2</sup> 1024x768 Fanless Panel PC with 12th Generation Intel® Core™ i3 on-board Processor,TDP 15W,8GB LPDDR4 on-board, without WiFi&Bluetooth module, PCAP touch,12V DC,R10
AFL4-12-ADL-P-CE/ W/8G-R10	12.1" 500cd/m <sup>2</sup> 1024x768 Fanless Panel PC with 12th Generation Intel® Celeron® G on-board Processor,TDP 15W,8GB LPDDR4 on-board, without WiFi&Bluetooth module, PCAP touch,12V DC,R10

## 可选配件 Options

料号	描述
-	TBD
-	TBD
-	TBD
-	TBD
-	TBD