

DM2-UW123J

IEI's Next Generation Industrial Monitor

- Front OSD, easy access for panel parameter adjustment
- Speakers positioned at the front, ensuring clear sound delivery even in panel mount
- Supports gloved operation and waterproof protection
- Built-in camera, ideal for AI facial recognition
- USB 3.2 Gen1 Type-A supports 10W
- IP65 compliant front panel with aluminum frame
- Anti-glare and anti-UV PCAP



www.ieiworld.com



DM2-UW123J

The DM2 series LCD monitor is the latest member of IEI's line of sophisticated LCD designs with flat bezel. It is designed to fit industrial automation. The flat front panel provides IP 65 protection, which effectively wards off dust and water. Flexible analog or digital interfaces are provided for ease of connection with a management computer.



Front -accessible OSD

The front-accessible OSD lets you easily control brightness, volume, and power on/off.



Support HDMI, VGA, DP

The DM2 series offers different display interfaces, such as HDMI, VGA, and DP, to suit various requirements.



Anti-glare and Anti-UV PCAP

With anti-glare and anti-UV coating, the 10-point touchscreen can display clearly without reflection.



IP65 rated front panel protection

With the IP65 front panel protection rating, this series is more durable and rugged, ensuring reliable operation in harsh industrial environments.



Built-in Camera

The DM2 series, equipped with a built-in camera, is perfectly suited for AI facial recognition applications.

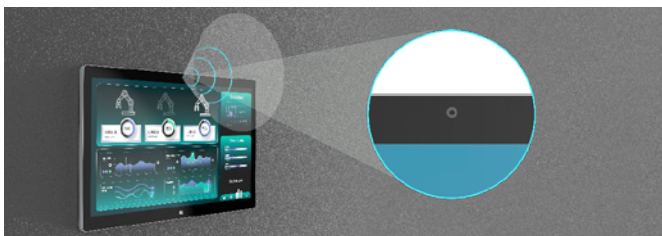

Front Speakers

The speakers are positioned at the front to guarantee clear sound delivery, even when panel-mounted.



Fully Integrated I/O

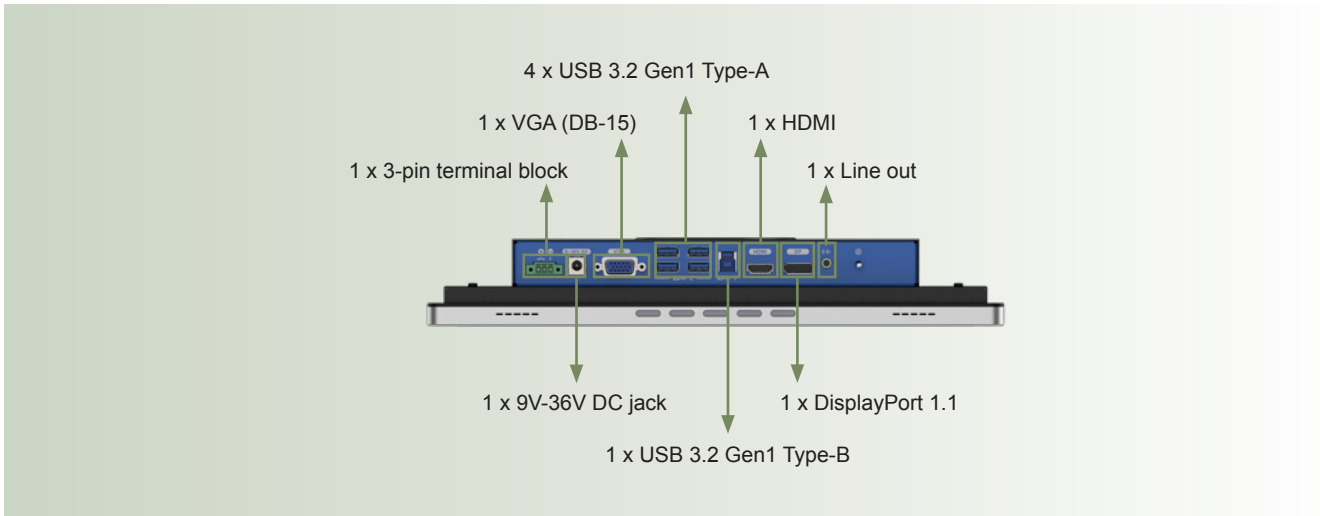

Block Diagram

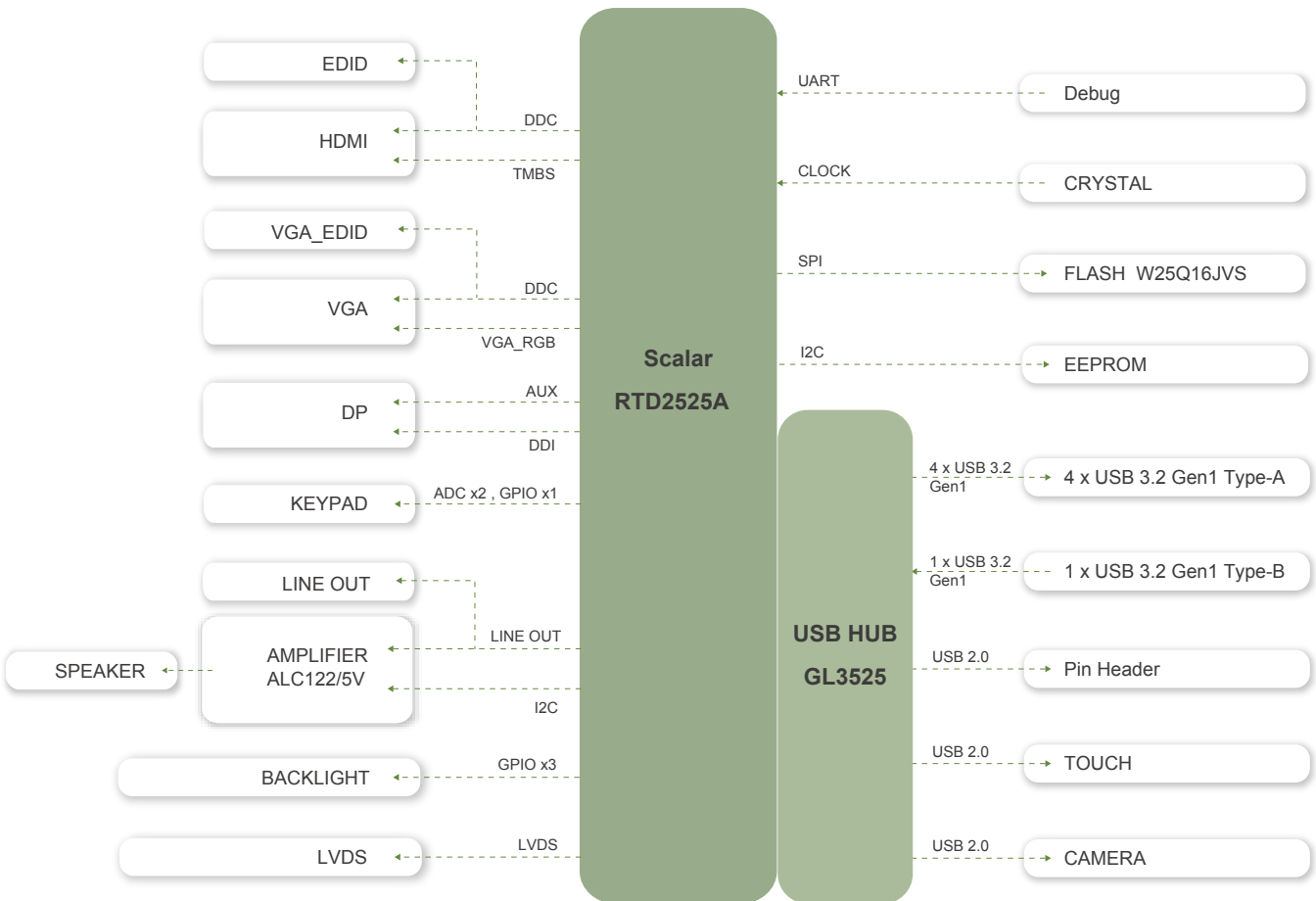

Dimensions (Unit: mm)

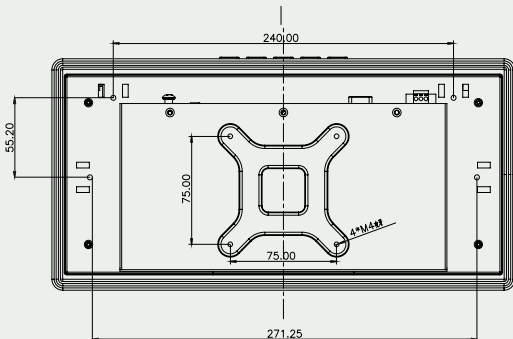
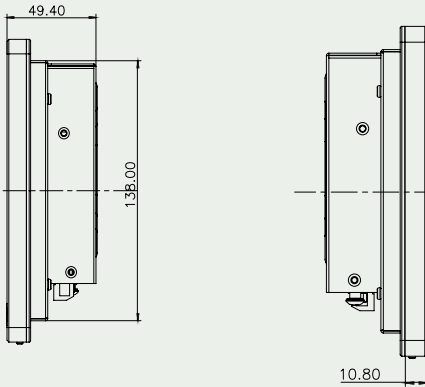
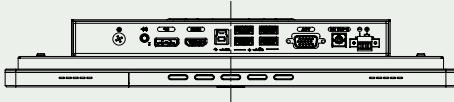
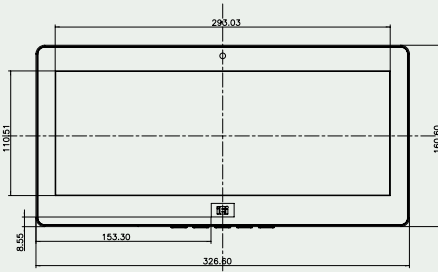
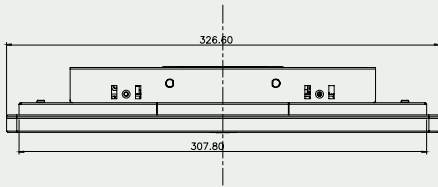

Specifications

Model Name	DM2-UW123J(L)	
LCD Size	12.3"(8:3)	
Brightness (cd/m ²)	850	
Max Resolution (W-H)	1920x720	
Contrast Ratio	1500 : 1	
LCD Color	16.7M	
Viewing Angle (H-V)	170°/170°	
Backlight MTBF (hrs)	30000	
Touch Screen	10-point projected capacitive touch window (anti-UV, anti-glare surface)	
Touch Controller	Capacitive: ilitek	
I/O Ports and Switches	1 x VGA (DB-15) 1 x HDMI 1 x USB 3.2 Gen1 Type-B 4 x USB 3.2 Gen1 Type-A *	1 x Line out 1 x DisplayPort 1.2 1 x 9V-36V DC jack 1 x 3-pin terminal block
OSD Keypad	5-key membrane OSD keypad	
Camera	720P Wide Angle Fixed Focus*	
Speaker	2 x 2W AMP (internal speaker)*	
Construction Material	Aluminum front frame and sheet metal rear cover	
Mounting	Panel mount, VESA 75	
Enclosure Color	Black+Silver	
Dimensions (LxWxH) (mm)	326.60 x 160.60 x 49.4	
Cutout Dimensions (mm)	310.80 x 141.00	
Operating Temperature	-20°C ~ 60°C (with air flow)	
Storage Temperature	-20°C ~ 70°C	
Humidity	10% to 95%@40°C (non-condensing) (50%@60°C)	
Vibration	MIL-STD-810F 514.5C-1	
Shock	Operating:Half-sine wave shock 5G; 11ms; 100 shocks per axis No-operating:Half-sine wave shock 15G; 11ms; 100 shocks per axis	
IP Level	IP 65 compliant front panel	
Safety & EMC	CE/FCC/UKCA Class B	
Power Input	9~36V DC	
Weight (Net/Gross)	1.9kg / 3.4kg	
Power consumption	12V@5.2A / 12V@1.9A(Lite Version)	

* L (Lite) without Camera, Speaker, USB-A x 4

Ordering Information

DM2-UW123J-R10	12.3" 850 cd/m ² 1920 x 720 monitor, VGA, HDMI, DisplayPort, with USB 3.0 HUB, USB PC touch screen, 9 ~36V DC input, Speaker, Camera, R10
DM2-UW123JL-R10	12.3" 850 cd/m ² 1920 x 720 monitor, VGA, HDMI, DisplayPort, USB PC touch screen, 9 ~36V DC input, Lite, R10

Packing List

Item	P/N	Q'ty	Remark
USB Cable	32001-032200-100-RS	1	USB 3.0 Type-A Male to Type-B Male cable, 100 cm
3-pin Terminal Block	33502-000188-RS	1	/
VESA Screws	44033-040062-RS	4	M.4
Panel Mount Kit	19XM0SFE0-0004601-000-RS 19XM0SFE0-0004602-000-RS	2 4	/

Options

Item	Part No.
Stand	STAND-C19-R10; STAND-A21-R10
Wall Mount	AFLWK-12
Power Adapter	63040-010096-050-RS (96W) 63040-010060-200-RS (60W) (Lite Version)
Power Cord	32702-000202-100-RS (EU)