

# TANK-XM811

- High-Performance 12<sup>th</sup> Generation Intel® Core™ Processor
- Fanless Embedded Computer

**New**

## Features

- Supported CPUs:
  - Intel® Core™ i5-12500TE 1.9 GHz (up to 4.3 GHz, 6-core, 35W TDP)
  - Intel® Core™ i7-12700TE 1.4 GHz (up to 4.6 GHz, 12-core, 35W TDP)
  - Intel® Core™ i9-12900TE 1.1 GHz (up to 4.8 GHz, 16-core, 35W TDP)
- 2 x 2.5G Ethernet ports
- Multiple USB ports and serial ports
- Multiple internal expansion boards for flexible selection
- Various optional backplanes and chassis
- CE/FCC compliant

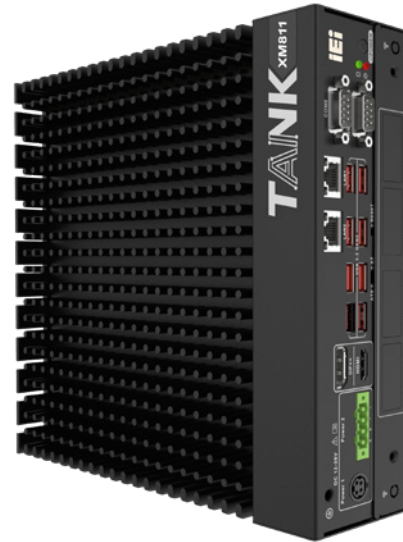

## Specifications

Model Name		TANK-XM811
Chassis	Color	Black C
	Dimensions (WxDxH) (mm)	230.6 x 256.04 x 76.2
	System Fan	Fanless
	Chassis Construction	Extruded aluminum alloys
Motherboard	CPU	12 <sup>th</sup> Gen Intel® Core™ CPU 35/65W TDP Intel® Core™ i5-12500TE 1.9 GHz (up to 4.3 GHz, 6-core, 35W TDP) Intel® Core™ i7-12700TE 1.4 GHz (up to 4.6 GHz, 12-core, 35W TDP) Intel® Core™ i9-12900TE 1.1 GHz (up to 4.8 GHz, 16-core, 35W TDP)
	Chipset	R680E
	Memory	2 x SO-DIMM DDR4 3200 (8GB pre-installed) (up to 64GB)
Storage	HDD Bay	1 x 2.5" SATA 6Gb/s HDD/SSD bay
I/O Interfaces	Ethernet	2 x RJ-45, 1 x I225V & 1 x I225-LM 2.5GbE
	USB 3.2 Gen 2 (10Gb/s)	8
	COM	2 x RS-232/422/485, 4 x RS-232
	Digital I/O	12-bit (6-in/6-out) DB15
	Display Interface	1 x DP++, 1 x HDMI
Internal Expansions	M.2	1 x 2280 M-key (PCIe x4) 1 x 2230 A-key (USB+PCIe x1, supports vPRO)
	Expansion Backplane	Optional
Power	Power Input	12 ~ 28V DC
	Remote Power	1 x 2-pin
	Power Consumption	12V @ 8.8A (Intel® Core™ i9-12900TE with 16GB memory)
Reliability	Mounting	Wall mount
	Operating Temperature	-20°C ~ 60°C with air flow (CPU TDP35W & SSD) -20°C ~ 50°C with air flow (CPU TDP65W & SSD), 10% ~ 95% non-condensing
	Storage Temperature	-40°C ~ 85°C, 10% ~ 95%, non-condensing
	Operating Shock	Half-sine wave shock 5G, 11ms, 100 shocks per axis (SSD)
	Operating Vibration	MIL-STD-810G 514.6C-1 (with SSD)
	Weight (Net/Gross)	3.33/3.7 kg
	Safety / EMC	CE/FCC
	Watchdog Timer	Programmable 1 ~ 255 sec/min
OS	Supported OS	Windows® 10/11 IoT Enterprise/ Linux

### Modular Design, Easy to Install

The mainboard is secured to the support bracket to prevent PCB from bending or warping. The three-layer structure consisting of heat spreader, mainboard and baseboard makes it easier to install CPU, memory and HDD, compared with the former TANK series.

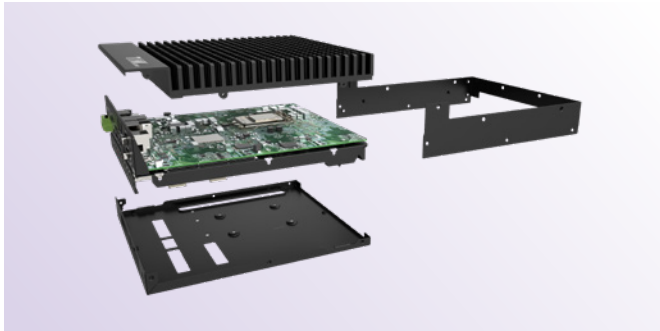

### Support High-performance Graphics Card

With IEI power board, it can support 3060 and other advanced graphics cards.

Maximum length of graphics card supported: 350mm

\*Specified power adapter is required.

#### NVIDIA 3060

\*Support advanced graphics card



### Flexible Expansion

Different expansion requirements can be met. Dual-slot and four-slot SKUs are provided for selection. Customers can choose the type of expansion slot according to their needs.



### External Fan

Installing an external fan helps to increase system performance in harsh environment.

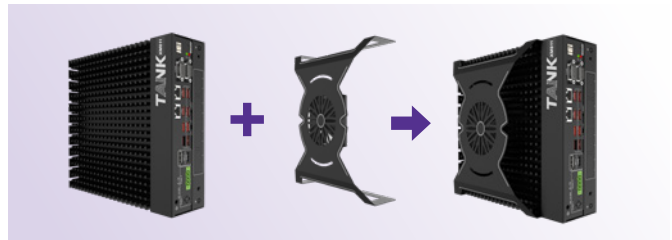

### Fully Integrated I/O

#### Top View

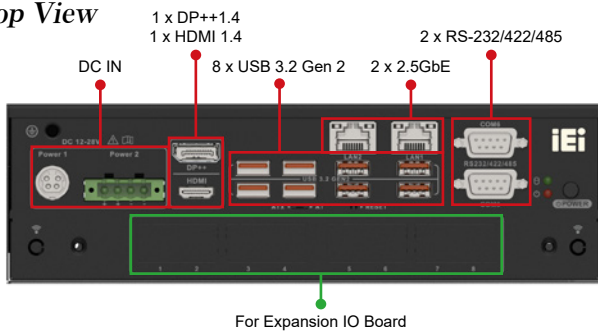

#### Front View

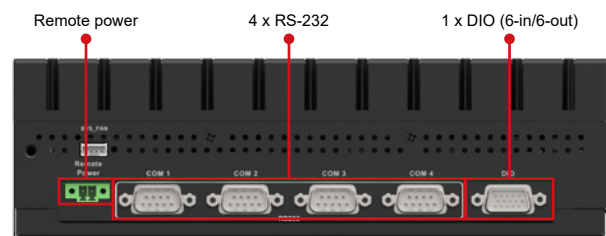

### Modular Board Design

It supports various optional modules, such as M.2 expansion card, 8-port PoE expansion card, etc.

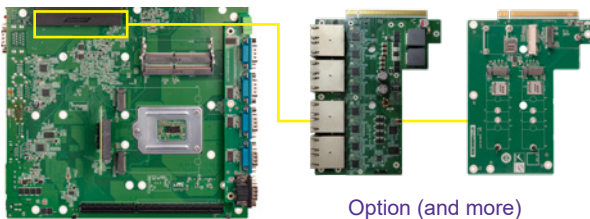

Option (and more)

Expansion IO Board	
GPOE-XM81-8P-R10	I/O expansion module for TANK 81 series, 8 x 2.5G LAN with PoE
TXIOB-XM81-A-R10	I/O expansion module for TANK 81 series, 2 x M.2 B Key, 1 x M.2 A Key, 1 x PCIe Mini

### Support 35W & 65W CPU

Operating temperature:	
With 35w CPU (or 65W CPU PL1 & PL2, default 35W):	-20°C ~ 60°C
With 65w CPU:	-20°C ~ 50°C

Dimensions (Unit: mm)

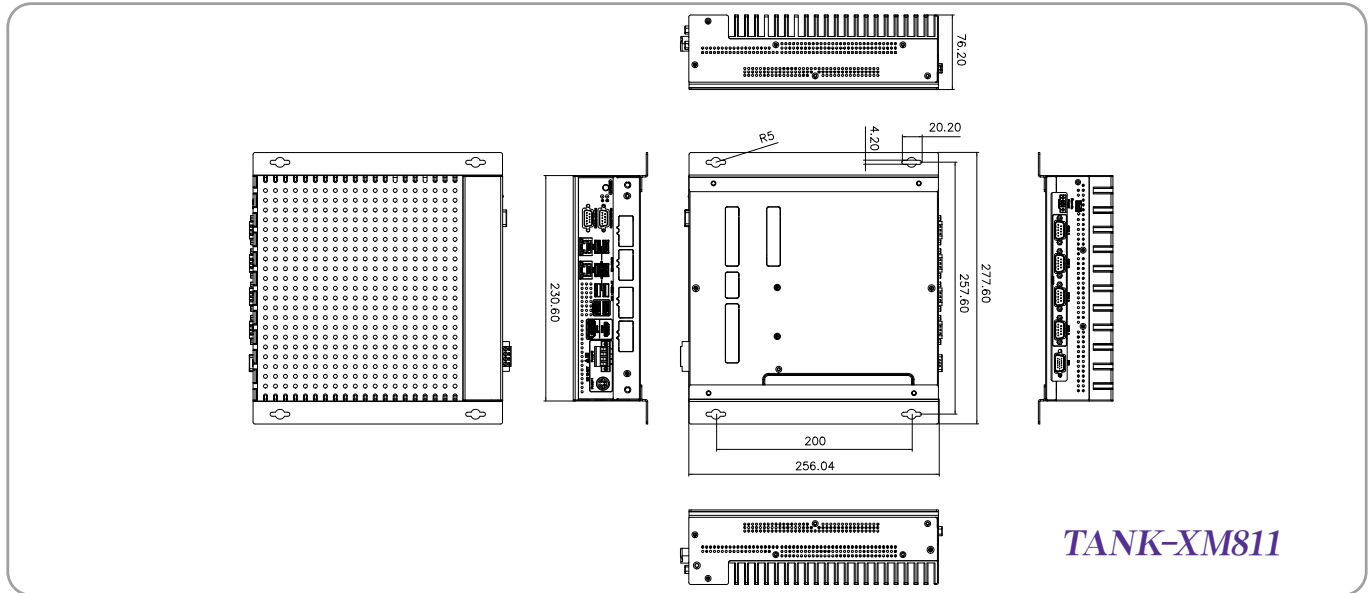

Ordering Information

Model	Description
TANK-XM811-I5AC-R10	Ruggedized Fanless Embedded System with Intel® Core™ i5, 8GB RAM, 1 x HDMI, 1 x DP++, 12~28V DC and RoHS
TANK-XM811-I7AC-R10	Ruggedized Fanless Embedded System with Intel® Core™ i7, 8GB RAM, 1 x HDMI, 1 x DP++, 12~28V DC and RoHS
TANK-XM811-I9AD-R10	Ruggedized Fanless Embedded System with Intel® Core™ i9, 16GB RAM, 1 x HDMI, 1 x DP++, 12~28V DC and RoHS

Options

Part No.	Description
EMB-WIFI-KIT02I3-R10	2T2R M.2 wifi module kit for embedded system, IEEE802.11a/b/g/n/ac/ax, 1 x M.2 AE Key Wireless LAN & Bluetooth 5.2; Intel; AX210. NGWG Module, 2 x RF cable, 2 x Antenna; RoHS
63040-010180-200-RS	Adapter Power; FSP; FSP180-ABAN3; 9NA1804008; Active PFC; Vin: 90~264VAC; 180W; Dim: 75.6*151.3*25.4mm; Plug=6.5mm; Cable=1500mm; Erp(NO LOAD 0.5W); Vout: 19VDC; Din 4Pin/lock; CCL; RoHS
32000-000002-RS	European power cord
SF-TANK-XM81-R10	External fan for TANK-XM81 Series

Optional Expansion Backplane

Part No.	Description
TXCBP-XM81-2A-R10	Expansion backplane module for TANK 81 Series, 2 slot, 1 x PCIe x16 & 1 x PCIe x4
TXCBP-XM81-2B-R10	Expansion backplane module for TANK 81 Series, 2 slot, 2 x PCIe x8
TXCBP-XM81-4A-R10	Expansion backplane module for TANK 81 Series, 4 slot, 1 x PCIe x16 & 2 x PCIe x4 & 1 x PCIe x1 w/ external power supply
TXCBP-XM81-4B-R10	Expansion backplane module for TANK 81 Series, 4 slot, 2 x PCIe x8 & 2 x PCIe x4 w/ external power supply
TXCBP-XM81-4C-R10	Expansion backplane module for TANK 81 Series, 4 slot, 1 x PCIe x16 & 2 x PCI & 1 x PCIe x4
TXCBP-XM81-G1-PW-R10	Expansion backplane module for TANK 81 Series, 4 slot, 1 x PCIe x16 & 1 x PCIe x4 w/ external power supply
TXCBP-XM81-G2-PW-R10	Expansion backplane module for TANK 81 Series, 6 slot, 2 x PCIe x8 & 2 x PCIe x4 w/ external power supply
IDD-X1228150-R10*	Extended Power Board for TANK-XM81 Series, 150W DC/DC 12-28V input 12V output

\* For expansion cards (graphics cards, accelerator cards) that require independent power supply to provide independent power supply, it must be equipped with a Backplane with W/external power supply function.

Optional Expansion Chassis

Part No.	Description
TXC-XM81-3S-R10	3-slot expansion chassis for TANK 81 Series
TXC-XM81-4S-R10	4-slot expansion chassis for TANK 81 Series
TXC-XM81-G1-R10	One GPU expansion chassis for TANK 81 Series
TXC-XM81-G2-R10	Dual GPU expansion chassis for TANK 81 Series

Optional Internal Expansion Boards

Part No.	Description
GPOE-XM81-8P-R10	I/O expansion module for TANK 81 Series, 8 x 2.5G LAN with PoE
TXIOB-XM81-A-R10	I/O expansion module for TANK 81 Series, 2 x M.2 B Key, 1 x M.2 A Key, 1 x PCIe Mini

Packing List

1 x Screw pack	2 x Terminal block	1 x Mounting bracket
----------------	--------------------	----------------------