

N-1417  
N-1419



### LCD Drawer Benefits

- ▶ Short depth design of 480mm (18.9") only
- ▶ Depth will suit a 600mm rack application
- ▶ "One Man" installation slides for easy, quick installation
- ▶ 104 key notepad keyboard with full numerical pad

### Drawer Features & Options

- 1U rackmount drawer with either 17" or 19" LCD
- Combo interface either PS/2 or USB input to the LCD drawer
- Multiple keyboard language selections with either touchpad or trackball
- Slide rails with fixed positions to prevent drawer movement when typing
- An aesthetically enhanced latching front panel to release the two point lock

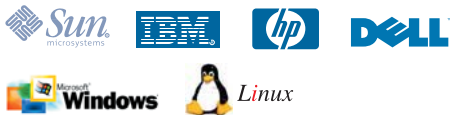

**Options** *page 103~104 for full details*



BNC + S-Video



DVI-D



DC Power



Audio

#### S-Video + BNC



#### DC Power

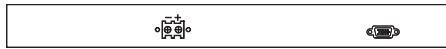

#### DVI-D

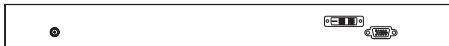

#### Audio



**\*\*With DVI-D or DC power option, the depth of N-1417 / N-1419 will be extended from 480mm ( 18.9" ) to 530mm ( 20.9" )**

### Diagram

Unit : mm

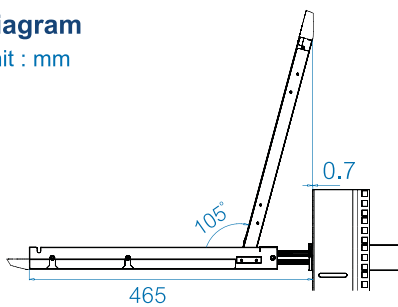

**Monitor**  Grade A 17" or 19" industrial TFT LCD panel *page 105 for full monitor details*

### Dimensions

Model	Product Dimension ( W x D x H )	Packing Dimension ( W x D x H )	Net Weight	Gross Weight
N-1417 Series	442 x 480 x 44 mm 17.4 x 18.9 x 1.73 inch	581 x 705 x 175 mm 22.9 x 27.8 x 6.9 inch	15 kg / 33 lbs	19 kg / 42 lbs
N-1419 Series	442 x 480 x 44 mm 17.4 x 18.9 x 1.73 inch	581 x 705 x 175 mm 22.9 x 27.8 x 6.9 inch	16 kg / 35 lbs	20 kg / 44 lbs

back



# Model Selection

Base Model	17" LCD Series	19" LCD Series
<ul style="list-style-type: none"> <li>• Single port w/o KVM</li> <li>• Combo interface</li> </ul>	N-1417	N-1419

## Keyboard Selection

Supporting layouts



### Ne N keyboard integrated with touchpad

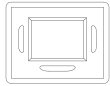
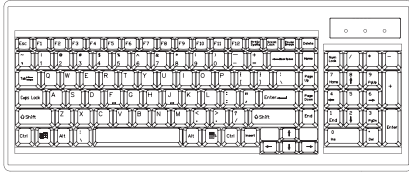

### Nb N keyboard integrated with trackball

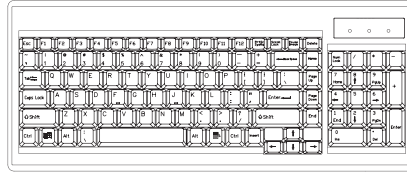

page 106 for full keyboard details