

RKP-2415
RKP-2417
RKP-2419



LCD Drawer & KVM Benefits

- ▶ 2U dual slide rackmount drawer with either 15", 17" or 19" LCD
- ▶ Short depth design of 480mm (18.9") only
- ▶ Depth will suit a 600mm rack application
- ▶ Multi-user Matrix KVM with either 16 or 32 ports in 2U
- ▶ Cost efficient Combo KVM integration
- ▶ Secure remote user access across the world wide web
- ▶ "One Man" installation slides for easy, quick installation

Drawer Features & Options

- Combo interface either PS/2 or USB input to the LCD drawer
- Multiple keyboard language selections with either touchpad or trackball
- Slide rails with fixed positions to prevent drawer movement when typing
- Enhanced aesthetics with new molded front panel and two point lock



Options page 103~104 for full details



BNC + S-Video



DVI-D



DC Power



Touch Screen



Audio

BNC + S-Video



Touchscreen - USB

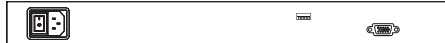

DVI-D

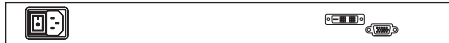

Touchscreen - Serial

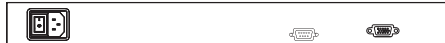

DC Power



Audio

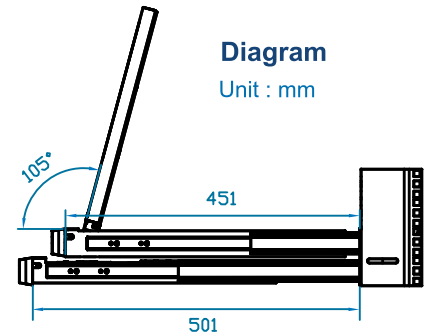

**With DC power option, the depth of RKP-2415 / RKP-2417 / RKP-2419 will be extended from 480mm (18.9") to 530mm (20.9")

Monitor Grade A 15", 17" or 19" industrial TFT LCD panel page 105 for full monitor details

Dimensions

Model	Product Dimension (W x D x H)	Packing Dimension (W x D x H)	Net Weight	Gross Weight
RKP-2415 / RKP-2417	442 x 480 x 88 mm 17.4 x 18.9 x 3.5 inch	584 x 616 x 216 mm 23 x 24.3 x 8.5 inch	17 kg / 37 lbs	23 kg / 51 lbs
RKP-2419	442 x 480 x 88 mm 17.4 x 18.9 x 3.5 inch	584 x 616 x 216 mm 23 x 24.3 x 8.5 inch	18 kg / 40 lbs	24 kg / 53 lbs

Keyboard Selection

Supporting layouts



Ne N keyboard integrated with touchpad

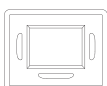
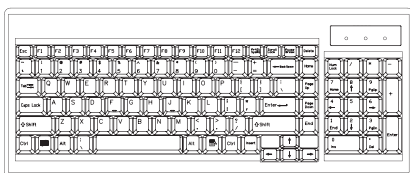

Nb N keyboard integrated with trackball

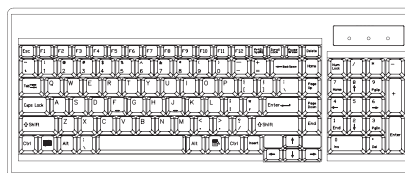

page 106 for full keyboard details

















KVM Selection















Base Model	15" LCD Series	17" LCD Series	19" LCD Series
<ul style="list-style-type: none"> • Single port w/o KVM • Combo interface 	RKP-2415	RKP-2417	RKP-2419

No KVM membrane button will be provided for all models
 page 23~38 for KVM specifications, page 107~110 for KVM rear I/O









Matrix Cat6 KVM

	2 consoles	Matrix Cat6 16 port	RKP2415 - MU 1602	RKP2417 - MU 1602	RKP2419 - MU 1602
	3 consoles		RKP2415 - MU 1603	RKP2417 - MU 1603	RKP2419 - MU 1603
	4 consoles		RKP2415 - MU 1604	RKP2417 - MU 1604	RKP2419 - MU 1604
	3 consoles	Matrix  Cat6 16 port	RKP2415 - MU IP 1613	RKP2417 - MU IP 1613	RKP2419 - MU IP 1613
	4 consoles		RKP2415 - MU IP 1614	RKP2417 - MU IP 1614	RKP2419 - MU IP 1614
	4 consoles		RKP2415 - MU IP 1624	RKP2417 - MU IP 1624	RKP2419 - MU IP 1624
	2 consoles	Matrix Cat6 32 port	RKP2415 - MU 3202	RKP2417 - MU 3202	RKP2419 - MU 3202
	3 consoles		RKP2415 - MU 3203	RKP2417 - MU 3203	RKP2419 - MU 3203
	4 consoles		RKP2415 - MU 3204	RKP2417 - MU 3204	RKP2419 - MU 3204
	3 consoles	Matrix  Cat6 32 port	RKP2415 - MU IP 3213	RKP2417 - MU IP 3213	RKP2419 - MU IP 3213
	4 consoles		RKP2415 - MU IP 3214	RKP2417 - MU IP 3214	RKP2419 - MU IP 3214
	4 consoles		RKP2415 - MU IP 3224	RKP2417 - MU IP 3224	RKP2419 - MU IP 3224







Matrix DB-15 KVM

	2 consoles	Matrix DB-15 8 port	RKP2415 - M 802	RKP2417 - M 802	RKP2419 - M 802
	3 consoles		RKP2415 - M 803	RKP2417 - M 803	RKP2419 - M 803
	4 consoles		RKP2415 - M 804	RKP2417 - M 804	RKP2419 - M 804
	3 consoles	Matrix  DB-15 8 port	RKP2415 - M IP 813	RKP2417 - M IP 813	RKP2419 - M IP 813
	4 consoles		RKP2415 - M IP 814	RKP2417 - M IP 814	RKP2419 - M IP 814
	4 consoles		RKP2415 - M IP 824	RKP2417 - M IP 824	RKP2419 - M IP 824
	2 consoles	Matrix DB-15 16 port	RKP2415 - M 1602	RKP2417 - M 1602	RKP2419 - M 1602
	3 consoles		RKP2415 - M 1603	RKP2417 - M 1603	RKP2419 - M 1603
	4 consoles		RKP2415 - M 1604	RKP2417 - M 1604	RKP2419 - M 1604
	3 consoles	Matrix  DB-15 16 port	RKP2415 - M IP 1613	RKP2417 - M IP 1613	RKP2419 - M IP 1613
	4 consoles		RKP2415 - M IP 1614	RKP2417 - M IP 1614	RKP2419 - M IP 1614
	4 consoles		RKP2415 - M IP 1624	RKP2417 - M IP 1624	RKP2419 - M IP 1624



Combo Cat6 KVM

	1 console	Combo Cat6 8 port	RKP2415 - U 801	RKP2417 - U 801	RKP2419 - U 801
	2 consoles		RKP2415 - U 802	RKP2417 - U 802	RKP2419 - U 802
	2 consoles		RKP2415 - U IP 802	RKP2417 - U IP 802	RKP2419 - U IP 802
	1 console	Combo Cat6 16 port	RKP2415 - U 1601	RKP2417 - U 1601	RKP2419 - U 1601
	2 consoles		RKP2415 - U 1602	RKP2417 - U 1602	RKP2419 - U 1602
	2 consoles		RKP2415 - U IP 1602	RKP2417 - U IP 1602	RKP2419 - U IP 1602
	1 console	Combo Cat6 32 port	RKP2415 - U 3201	RKP2417 - U 3201	RKP2419 - U 3201
	2 consoles		RKP2415 - U 3202	RKP2417 - U 3202	RKP2419 - U 3202
	2 consoles		RKP2415 - U IP 3202	RKP2417 - U IP 3202	RKP2419 - U IP 3202

Combo DB-15 KVM

	1 consoles	Combo DB-15 8 port	RKP2415 - S 801	RKP2417 - S 801	RKP2419 - S 801
	2 consoles		RKP2415 - 802	RKP2417 - 802	RKP2419 - 802
	2 consoles		RKP2415 - IP 802	RKP2417 - IP 802	RKP2419 - IP 802
	1 console	Combo DB-15 16 port	RKP2415 - S 1601	RKP2417 - S 1601	RKP2419 - S 1601
	2 consoles		RKP2415 - 1602	RKP2417 - 1602	RKP2419 - 1602
	2 consoles		RKP2415 - IP 1602	RKP2417 - IP 1602	RKP2419 - IP 1602

PS/2 DB-15 KVM

	1 console	 8 port DB-15 16 port	RKP2415 - 801 RKP2415 - 1601	RKP2417 - 801 RKP2417 - 1601	RKP2419 - 801 RKP2419 - 1601
---	-----------	---	---------------------------------	---------------------------------	---------------------------------