

MD-119 Hardware Manual

First Edition, February 2013

www.moxa.com/product

MOXA[®]

© 2013 Moxa Inc. All rights reserved.

MD-119 Hardware Manual

The software described in this manual is furnished under a license agreement and may be used only in accordance with the terms of that agreement.

Copyright Notice

© 2013 Moxa Inc. All rights reserved.

Trademarks

The MOXA logo is a registered trademark of Moxa Inc.
All other trademarks or registered marks in this manual belong to their respective manufacturers.

Disclaimer

Information in this document is subject to change without notice and does not represent a commitment on the part of Moxa.

Moxa provides this document as is, without warranty of any kind, either expressed or implied, including, but not limited to, its particular purpose. Moxa reserves the right to make improvements and/or changes to this manual, or to the products and/or the programs described in this manual, at any time.

Information provided in this manual is intended to be accurate and reliable. However, Moxa assumes no responsibility for its use, or for any infringements on the rights of third parties that may result from its use.

This product might include unintentional technical or typographical errors. Changes are periodically made to the information herein to correct such errors, and these changes are incorporated into new editions of the publication.

Technical Support Contact Information

www.moxa.com/support

Moxa Americas

Toll-free: 1-888-669-2872
Tel: +1-714-528-6777
Fax: +1-714-528-6778

Moxa Europe

Tel: +49-89-3 70 03 99-0
Fax: +49-89-3 70 03 99-99

Moxa China (Shanghai office)

Toll-free: 800-820-5036
Tel: +86-21-5258-9955
Fax: +86-21-5258-5505

Moxa Asia-Pacific

Tel: +886-2-8919-1230
Fax: +886-2-8919-1231

Table of Contents

1. Introduction	1-1
Overview	1-2
Package Checklist	1-2
Product Features	1-2
MD-119 Hardware Specifications	1-3
2. Hardware Introduction	2-1
Appearance and Layout	2-2
Dimensions	2-3
LED Indicators	2-3
On-screen Display Control Buttons	2-3
3. Hardware Installation and Peripherals	3-1
Installing the MD-119	3-2
Wiring Requirements	3-2
Connecting Power Sources	3-3
Grounding the MD-119	3-3
Connecting Data Transmission Cables	3-3
Connecting to a Serial Device	3-3
Connecting to Computers or Laptops	3-4
Enabling the Built-in Buzzer	3-5
A. Regulatory Approval Statement	A-1
B. On-screen Display and Display Configuration	B-1
On-screen Display (OSD) Controls	B-2
Opening the Configuration Screen	B-2
OSD Passwords/Keycode	B-2
OSD Filetree Legend	B-3
OSD Menu Map	B-3
Main Group 1	B-4
Main Group 2	B-5
Main Group 3	B-6
OSD Menu Items Explained	B-7
Basic Image Properties	B-7
Picture: PIP Adjustments	B-8
Picture: Advanced Settings	B-9
Swap Input Sources: Main to Second / Second to Main	B-11
Image Information	B-12
Auto-Setup	B-12
Display Setup: OSD	B-12
Display Setup: User Settings	B-14
Display Setup: Preset Defaults	B-15
Display Setup: Service Menu	B-16
Display: Input Sources / Dual Image Displays	B-16
Power Off	B-18
C. Display UART Command	C-1
Connecting to the Display	C-2
UART Software Configuration	C-2
Date Rate	C-2
Data Format	C-2
UART Command Format	C-2
Command Format Description	C-2
Downloading Files	C-4
Downloading Files	C-4
Downloading Dual RGB File	C-5
Uploading/Downloading Configuration Files	C-5
OSD Control Command	C-6
BLI (Brightness Control)	C-6
DST (Display State)	C-6
MAN (Manufacturer ID Code)	C-6
POT (Potentiometer Control)	C-7
SNB (Serial Number Query)	C-7
TYP (Type/Model/Number Query)	C-7
SWI (Software Version Query)	C-8
VER (Version Number)	C-8
MCC (OSD Control)	C-8
MCC Control Command	C-9

Introduction

The MD-119 Series displays are designed to meet exacting performance and durability standards. The 19-inch panels featuring a 4:3 aspect ratio, 1280 x 1024 pixel resolution, full range dimming, and optional optical bonding make these displays ideal for a variety of applications. These computer display terminals further meet required industrial standards and are perfectly suited for a wide variety of industrial uses that require rugged, reliable performance, whether indoors or out.

Further, these displays use either AC or DC power inputs, simplifying the installation of the displays at field sites, and also offer PIP (Picture-In-Picture) and PBP (Picture-By-Picture) modes, allowing for multiple image display configurations on a single screen.

The following topics are covered in this chapter:

- ❑ **Overview**
- ❑ **Package Checklist**
- ❑ **Product Features**
- ❑ **MD-119 Hardware Specifications**

Overview

The MD-119 Series has been designed to fit the peculiar environmental demands of industrial systems. The 19-inch panel features a 4:3 aspect ratio and a 1280 x 1024 pixel resolution, making this display ideal for any industrial application requiring detailed, high-resolution imagery. In addition, with full range dimming, optical bonding (optional), these computer display terminals satisfy a variety of international standards.

Package Checklist

The MD-119 Series includes the following models:

MD-119: 19-inch industrial display with 4:3 aspect ratio, LED backlighting, multiple input AC/DC power supply, and tape bonding; optical bonding and capacitance touch screens are available as optional requests

Each model ships with the following items:

- MD-119 display
- DVI to VGA adapter
- VGA Cable
- DVI-D Cable
- Console Mounting Kits
- DC terminal block (for powering device)
- DC terminal block (for powering the buzzer)
- Documentation and driver DVD
- Quick installation guide (printed)
- Warranty card

NOTE Please notify your sales representative if any of the above items are missing or damaged.

Product Features

The MD-119 display has the following features:

- 19-inch wide viewable image size with 4:3 aspect ratio and 1280 x 1024 pixel resolution
- LED backlighting
- Optical bonding (optional)
- Surface capacitance touch panel (optional)
- Picture-in-picture / picture-by-picture (PIP/PBP)
- Multi-power input (24 VDC, 110 to 230 VAC)
- IP54 rated front panel

MD-119 Hardware Specifications

Display

Panel Size: 19" wide viewable image size

Panel Type: TN

Aspect Ratio: 4:3

Pixels: 1280 x 1024 (SXGA)

Pixel Pitch (RGB): 0.282 (H) x 0.282 (V) mm

Response Time: 5 ms (typical)

Contrast Ratio: 1000:1 (typical)

Light Intensity: 350 cd/m²

Viewing Angles: 85° x 80° (Right-Left x Up-Down)

Active Display Area: 376.32 (H) x 301.06 (V) mm/14.81(H) x 11.85 (V) (inch)

Max Colors: 16.7M (8 bits/color)

Display Interface: VGA output x 1, DVI-I input x 2, BNC composite x 3

Serial Interface

Console Port: 2 RS-232/422/485 ports, (1 is manufacture reserved), (DB9 male)

Serial Communication Parameters

Data Bits: 5, 6, 7, 8

Stop Bits: 1, 1.5, 2

Parity: None, Even, Odd, Space, Mark

Baudrate: 9600 bps

Serial Signals

RS-232: TxD, RxD, DTR, DSR, RTS, CTS, DCD, GND

RS-422: TxD+, TxD-, RxD+, RxD-, GND

RS-485-4w: TxD+, TxD-, RxD+, RxD-, GND

RS-485-2w: Data+, Data-, GND

Front Panel

OSD: 5 x OSD control

Physical Characteristics

Housing: Aluminum sheet metal

Weight: 9.69 kg

Dimensions: 82 x 483 x 444 mm (3.29 x 19.02 x 17.48 in)

Mounting: Console mounting

Environmental Limits

Operating Temperature: -15 to 55°C (5 to 131°F)

Storage Temperature: -20 to 60°C (-4 to 140°F)

Ambient Relative Humidity: 5 to 95% (non-condensing)

Anti-Vibration:

- IEC 60945
- DNV 2.4, Class A/Class C

Power Requirements

Input Voltage:

- 24 VDC (with tolerance from 18 to 36 VDC), 2-pin screw-type terminal block
- 110 to 230 VAC, 50/60 Hz

Power Consumption: 42 W

- 75W (standard)
- 90W (full loading)

Standards and Certifications

Safety: UL/cUL, CCC (Pending)

EMC: EN 55022 Class B, EN 55024-4-2, EN 55024-4-3, EN 55024-4-4, FCC Part 15 Subpart B Class A

Marine: IEC 60945 4th (Pending), DNV (Pending), IACS-E10 (Pending)

IP Rating: IP54 (IP66 by request)

Compass Safe Distance: <80cm (to be tested by DNV)

Green Product: RoHS, cRoHS, WEEE

Warranty

Warranty Period: One year

Details: See www.moxa.com/warranty

We recommend taking the following precautions to minimize heat build-up within the display:

- Position the display within $\pm 40^\circ$ of the vertical
- If:
 - (a) the display is not positioned within $\pm 40^\circ$ of the vertical, or
 - (b) the operating temperature exceeds 25°C , or
 - (c) the display is used in a location with minimal ventilation,then install an external fan to increase airflow upwards through the chassis

Important Safety Precaution:

Even though the display is rated to operate within the IEC 60945 standard of -15 to 55°C for industrial applications, it is best to ensure that the operating temperature does not exceed 25°C . Doing so will significantly increase the lifespan of your display and reduce service costs.

Hardware Introduction

The MD-119 display is compact, well-designed, and rugged enough for industrial applications. LED indicators help you monitor performance and identify trouble spots, multiple serial ports allow you to connect different devices for wireless operation, and the reliable and stable hardware platform lets you devote your attention to developing your applications.

The following topics are covered in this chapter:

- ❑ **Appearance and Layout**
- ❑ **Dimensions**
- ❑ **LED Indicators**
- ❑ **On-screen Display Control Buttons**

Appearance and Layout

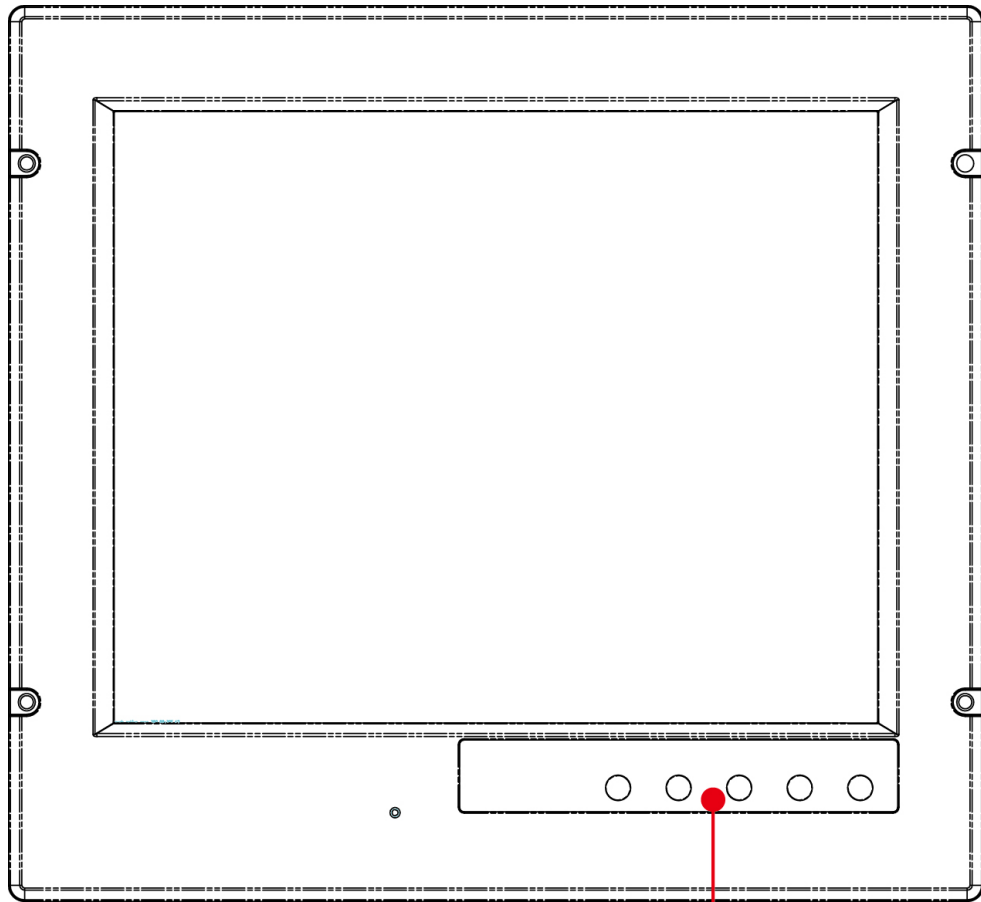

OSD Control Buttons

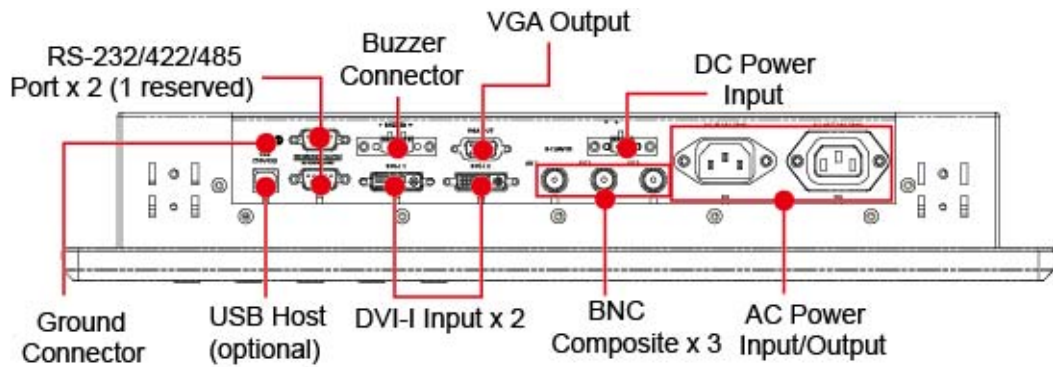

Dimensions

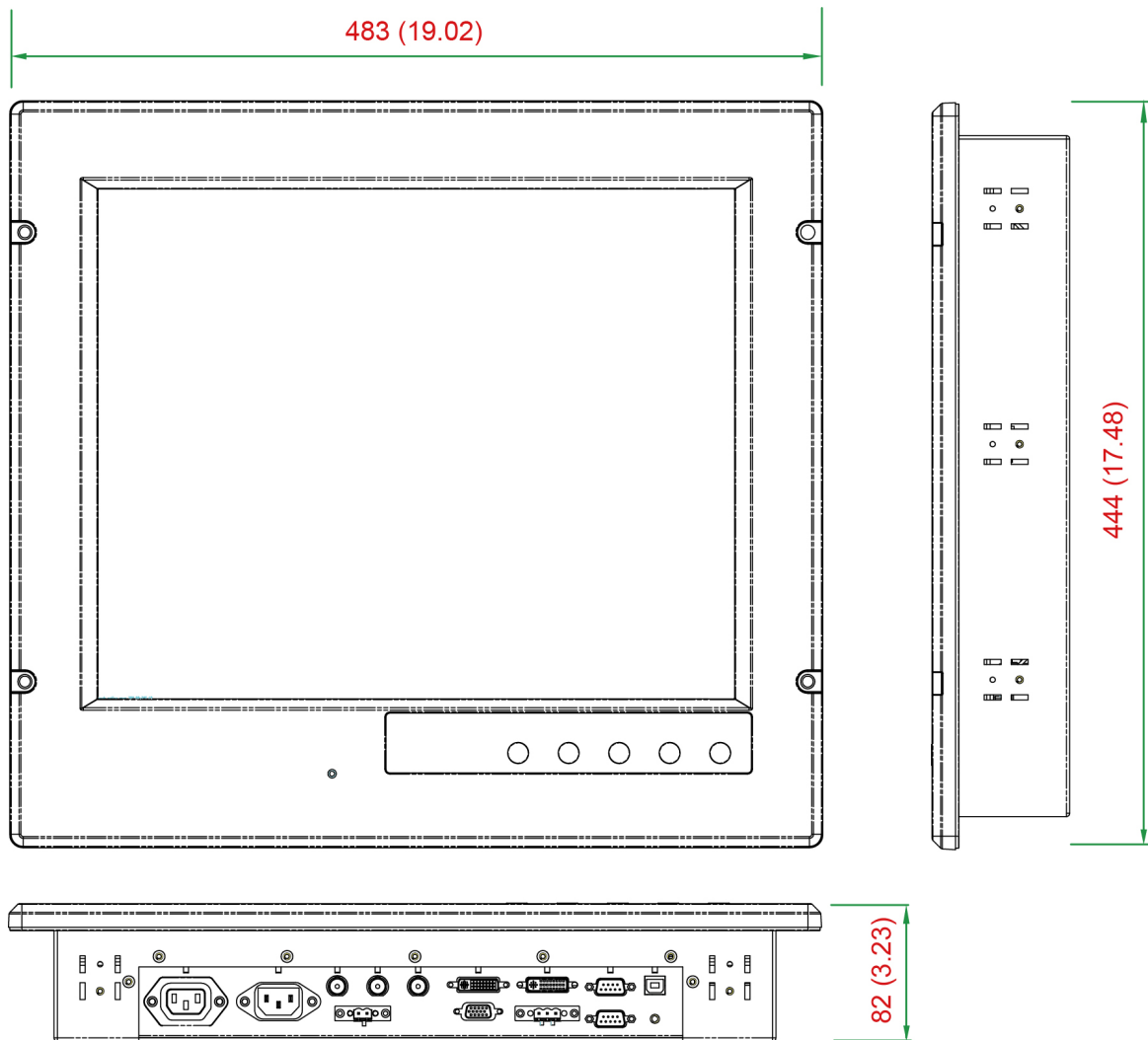

LED Indicators

LED Name	LED Color	LED Function
Power	Green	Power is on and functioning normally
	Yellow	Display is suspended

On-screen Display Control Buttons

The front panel of the MD-119 comes with a power button and four on-screen display (OSD) control buttons for accessing and adjusting image properties. Please refer to Appendix B for detailed explanations of individual items on the OSD menu and adjusting image properties.

Hardware Installation and Peripherals

In this chapter, we show how to connect the MD-119 to its central processing unit and to various devices.

The following topics are covered in this chapter:

- ❑ **Installing the MD-119**
- ❑ **Wiring Requirements**
- ❑ **Connecting Power Sources**
- ❑ **Grounding the MD-119**
- ❑ **Connecting Data Transmission Cables**
 - Connecting to a Serial Device
- ❑ **Connecting to Computers or Laptops**
- ❑ **Enabling the Built-in Buzzer**

Installing the MD-119

Cabinet Mounting

The MD-119 comes with a console mounting kit that helps users mount the display into a cabinet. There are eleven sets of console mounting holes on four sides of the MD-119. Each mounting point has two standards-compliant locations for screws to go into, depending on the thickness of the wall or cabinet. Simply fasten the screws to the mounts in the correct place.



For safety reasons, it is important to ensure that all four corners and sides of the panel are firmly attached to the cabinet, so that the display and cabinet assembly is stabilized.



ATTENTION

Clean the monitor using a soft material such as a microfiber cloth. You may also use LCD cleaning liquid to clean the monitor.

Avoid using coarse or rough material to clean the monitor as this may damage the surface of the display.

Wiring Requirements

This section describes how to connect serial devices to the display.

You should read and follow these common safety precautions before proceeding with the installation of any electronic device:

- Use separate paths to route wiring for power and devices. If power wiring and device wiring paths must cross, make sure to cut interference problems by keeping the wires perpendicular at the intersection points

NOTE

To avoid interference **do not**, in the same conduit, run signal or communication wiring together with power wiring. Wires with different signal characteristics should be routed separately.

- Use the type of signal transmitted through a wire to determine which wires should be kept separate. The rule of thumb is that wiring that shares similar electrical characteristics can be bundled together.
- Keep input wiring and output wiring separate.
- It is advisable to label the wiring to all devices in the system.



ATTENTION

Safety First!

Be sure to disconnect the power cord before installing and/or wiring your MD-119.

Wiring Caution!

Calculate the maximum possible current in each power wire and common wire. Observe all electrical codes dictating the maximum current allowable for each wire size.

If electrical current exceeds the maximum rating the wire will overheat; this will cause serious damage to your equipment.

Temperature Caution!

Be careful when handling the unit. When the unit is plugged in, the internal components generate a lot of heat, heating the outer casing.

Connecting Power Sources

The MD-119 offers 24 VDC power input with the terminal block, and also comes with a 110 to 230 VAC power input. If power is supplied properly, the **Power** LED will light up. To enable the power failover function, connect both AC and DC power inputs.

For safety reasons, please use cables with the following specifications:

Wire range: 14-22 AWG, torque 7 lb

Grounding the MD-119

Grounding and proper wiring layout help limit the effects of noise from electromagnetic interference (EMI). The ground wire must be a minimum 18 AWG, and must be connected (via the grounding screw) prior to connecting the power. The ground connector is located on the bottom panel of the display, as shown in the **Appearance and Layout** diagram on page 2-2.



ATTENTION

This product is intended to be mounted to a well-grounded mounting surface, such as a metal panel.

Connecting Data Transmission Cables

This section describes how to connect the MD-119 display to various interfaces.

Connecting to a Serial Device

Use a serial cable to plug your serial device into the display’s serial port. Please note that serial port 1 is reserved for the manufacturer’s configuration process; only serial port 2 is available for connecting serial peripherals. Serial port 2 terminates in a male 9-pin D-Sub (DE9) connector, and can be software-configured as an RS-232, RS-422, or RS-485 interface. The pin assignments are shown in the table on the following page:

DB9 Male Port

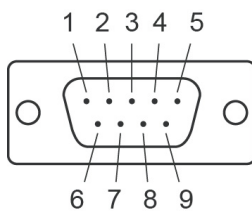

RS-232/422/485 Pinouts

Pin	RS-232	RS-422	RS-485 (4-wire)	RS-485 (2-wire)
1	DCD	TxDA(-)	TxDA(-)	-
2	RxD	TxDB(+)	TxDB(+)	-
3	TxD	RxDB(+)	RxDB(+)	DataB(+)
4	DTR	RxDA(-)	RxDA(-)	DataA(-)
5	GND	GND	GND	GND
6	DSR	-	-	-
7	RTS	-	-	-
8	CTS	-	-	-

Connecting to Computers or Laptops

The MD-119 comes with two DVI-I inputs, allowing to connecting two computers or laptops. In addition, a VGA output is available for extending to an additional display. Pin assignments are shown below:

DB15 Female Connector

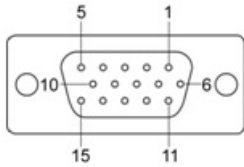

Pin No.	Signal Definition
1	Red
2	Green
3	Blue
4	NC
5	GND
6	GND
7	GND
8	GND
9	VCC
10	GND
11	NC
12	DDC Data
13	HSYNC
14	VSYSN
15	DDC Clock

DVI-I Connector

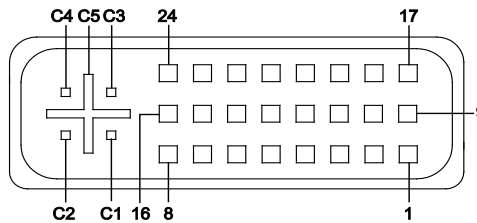

Pin No.	Signal Definition
1	T.M.D.S. Data2-
2	T.M.D.S. Data2+
3	T.M.D.S. Data2/4 Shield
4	N/C
5	N/C
6	DDC Clock
7	DDC Data
8	Analog Vertical Sync
9	T.M.D.S. Data1-
10	T.M.D.S. Data1+
11	T.M.D.S. Data1/3 Shield
12	N/C
13	N/C
14	+5V Power
15	Ground (return for +5V, HSync, and VSync)

Pin No.	Signal Definition
16	Hot Plug Detect
17	T.M.D.S. Data0-
18	T.M.D.S. Data0+
19	T.M.D.S. Data0/5 Shield
20	N/C
21	N/C
22	T.M.D.S. Clock Shield
23	T.M.D.S. Clock+
24	T.M.D.S. Clock-
C1	Analog Red
C2	Analog Green
C3	Analog Blue
C4	Analog Horizontal Sync
C5	Analog Ground (analog R, G, B return)

Enabling the Built-in Buzzer

The MD-119 comes with a built in a buzzer terminal block and is located on its bottom panel. Insert the leads from a 5 to 12 V power source into the terminal block to enable the buzzer for use.

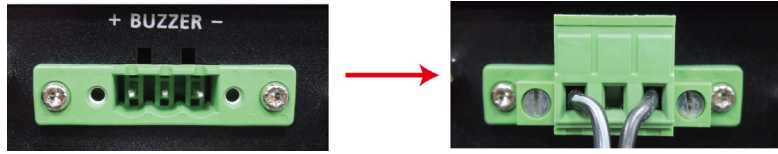

A

Regulatory Approval Statement



This device complies with part 15 of the FCC Rules. Operation is subject to the following two conditions: (1) This device may not cause harmful interference, and (2) this device must accept any interference received, including interference that may cause undesired operation.

Class A : FCC Warning! This equipment has been tested and found to comply with the limits for a Class A digital device, pursuant to part 15 of the FCC Rules. These limits are designed to provide reasonable protection against harmful interference when the equipment is operated in a commercial environment. This equipment generates, uses, and can radiate radio frequency energy and, if not installed and used in accordance with the instruction manual, may cause harmful interference to radio communications. Operation of this equipment in a residential area is likely to cause harmful interference in which case the user will be required to correct the interference at his/her own expense.



European Community

Warning:

This is a class A product. In a domestic environment this product may cause radio interference in which case the user may be required to take adequate measures.

B

On-screen Display and Display Configuration

This chapter discusses how to navigate the On-screen Display (OSD) and how to use the menus to adjust the panel's image properties.

The following topics are covered in this appendix:

❑ **On-screen Display (OSD) Controls**

- Opening the Configuration Screen

❑ **OSD Passwords/Keycode**

❑ **OSD Filetree Legend**

❑ **OSD Menu Map**

- Main Group 1
- Main Group 2
- Main Group 3

❑ **OSD Menu Items Explained**

- Basic Image Properties
- Picture: PIP Adjustments
- Picture: Advanced Settings
- Swap Input Sources: Main to Second / Second to Main
- Image Information
- Auto-Setup
- Display Setup: OSD
- Display Setup: User Settings
- Display Setup: Preset Defaults
- Display Setup: Service Menu
- Display: Input Sources / Dual Image Displays
- Power Off

On-screen Display (OSD) Controls

Opening the Configuration Screen

To configure the panel display settings, open the on-screen display (OSD) configuration panel by pressing the **Menu** button. The LCD panel will then display a configuration menu superimposed over the currently displayed image. The OSD controls consist of two LEDs (to indicate system status), a **MENU** button for opening and closing the OSD, and four arrow buttons for navigating the OSD menus.

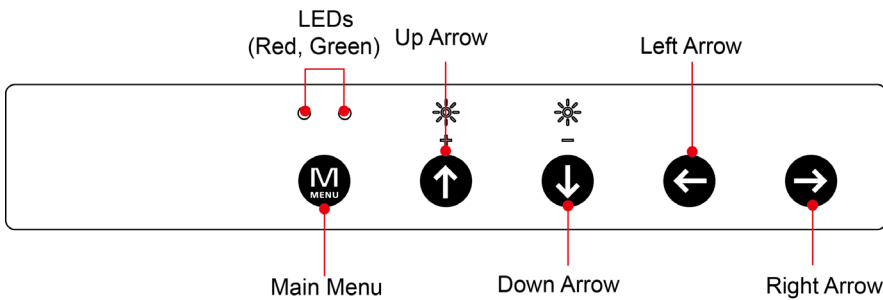

LED Indicators

The following table describes the LED indicators located on the front of the MD-119.

LED Name	LED Color	LED Function
(unmarked)	Green	Power is on and functioning normally
	Red	Display is suspended

Buttons

Right Arrow Key: Allows users to navigate to sub-menus from a specific menu item

Left Arrow Key: Allows users to exit a sub-menu and return to the previous menu

Up Arrow Key: Allows users to navigate the items of a single OSD menu, or increase the brightness of the display

Down Arrow Key: Allows users to navigate the items of a single OSD menu, or decrease the brightness of the display

OSD Passwords/Keycode

When pressing Menu button, you may be asked for a password, please use **321**.

When entering the Full Menu mode, you may be asked for a password, please use **158**.

OSD Filetree Legend

The OSD menu includes parameters that are specific for RGB mode, DVI mode and which are accessible depending on whether you are using the **Full** or "Simplified" menu structure. Not all functions shown in the menu structure are available in every mode. To more easily identify which parameters are available in a given mode, the illustrations in this section are marked with a color legend. These colors are not visible in the actual OSD environment.

- = Always available for all modes.
- = Always available for all modes.
- = Only available in "Full" menu mode.
- = Only available in RGB mode, i.e. VGA/RGB signal input is shown full screen.
- = Only available in "Full" and RGB modes.
- = Only available in DVI/RGB mode.
- = Only available in Comp/S-VHS mode, i.e. Video Signal is shown full screen.
- = Only available if Picture-In-Picture (PIP) or Picture-By-Picture (PBP) is on.

OSD Menu Map

The MD-119 OSD control is divided into 3 groups. See the following figures for details.

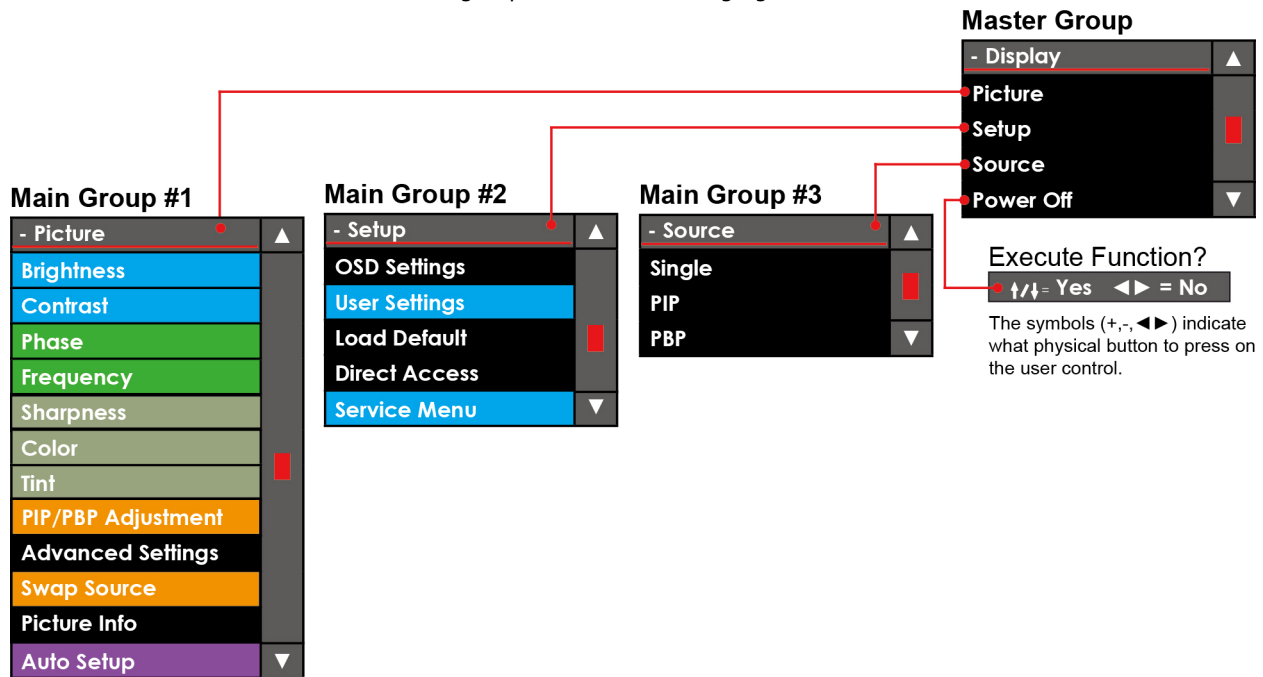

Main Group 1

In this group (and its sub groups) the user can adjust image properties that directly affect the picture across all incoming signal sources. Some of these subgroups have further options; please review this menu map to quickly determine where a desired property is located within the menu hierarchy. For detailed information about each item and its parameters, please review the **OSD Menu Items Explained** later in this section.

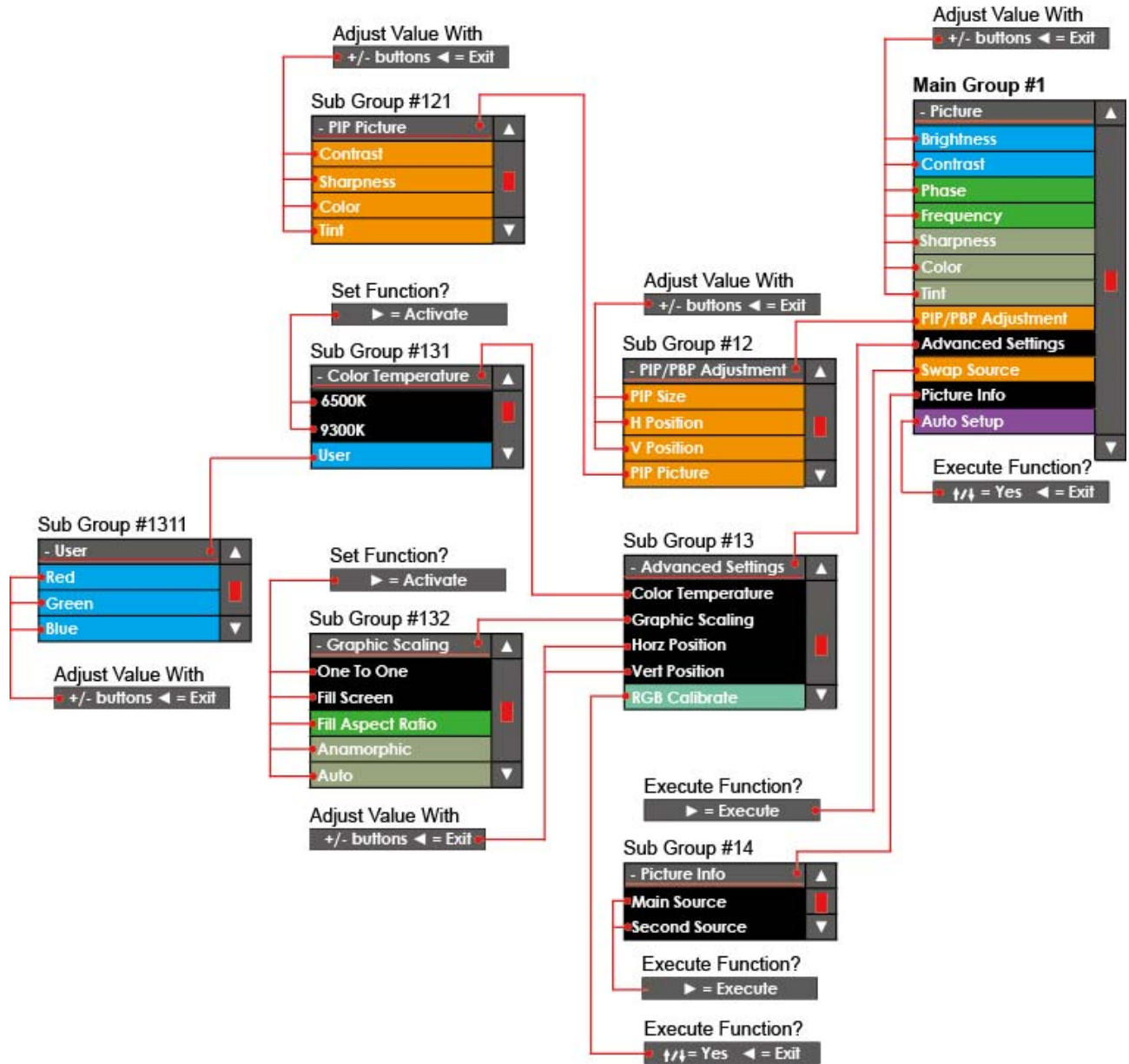

Main Group 2

In this group (with its subgroups) the user can adjust parameters that directly impact settings for the video controller software, OSD settings and gain access to settings that are physically accessible for the user. None of these settings will impact on the picture visually for the incoming signal sources. Some of these subgroups have more options, please review this map to quickly determine where a desired property is located within the menu hierarchy. For detailed information about each item and its parameters, please review the **OSD Menu Items Explained** later in this section.

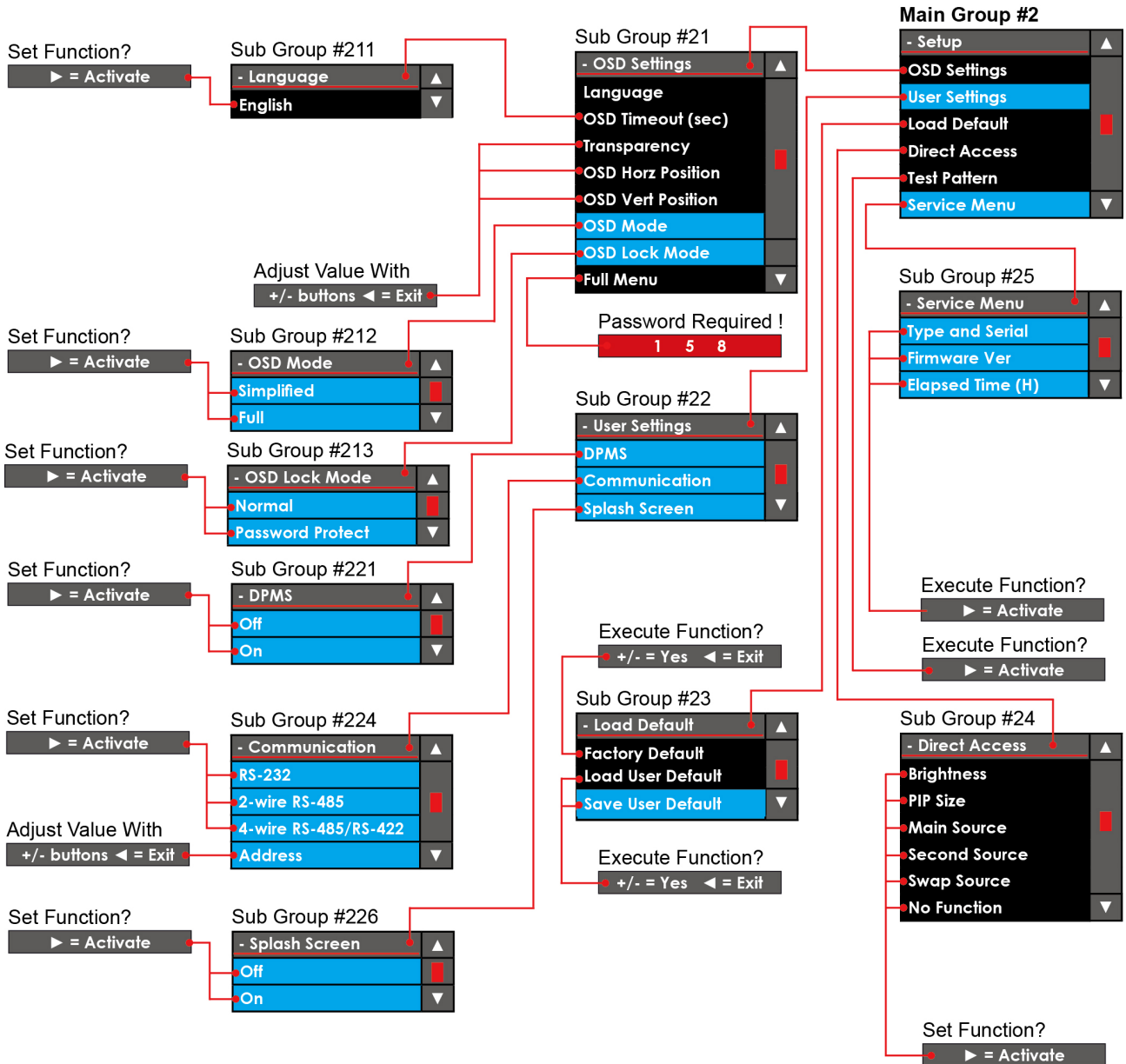

Main Group 3

In this group (with its subgroups) the user can change signal sources and set up the **Picture-In-Picture** or **Picture-By-Picture** views, both of which take advantage of the **Multi Display** feature. Some of these subgroups have more than one option, so please review this map to quickly determine where a desired setting is located within the menu hierarchy. For detailed information about each item and its parameters, please review the **OSD Menu Items Explained** later in this section.

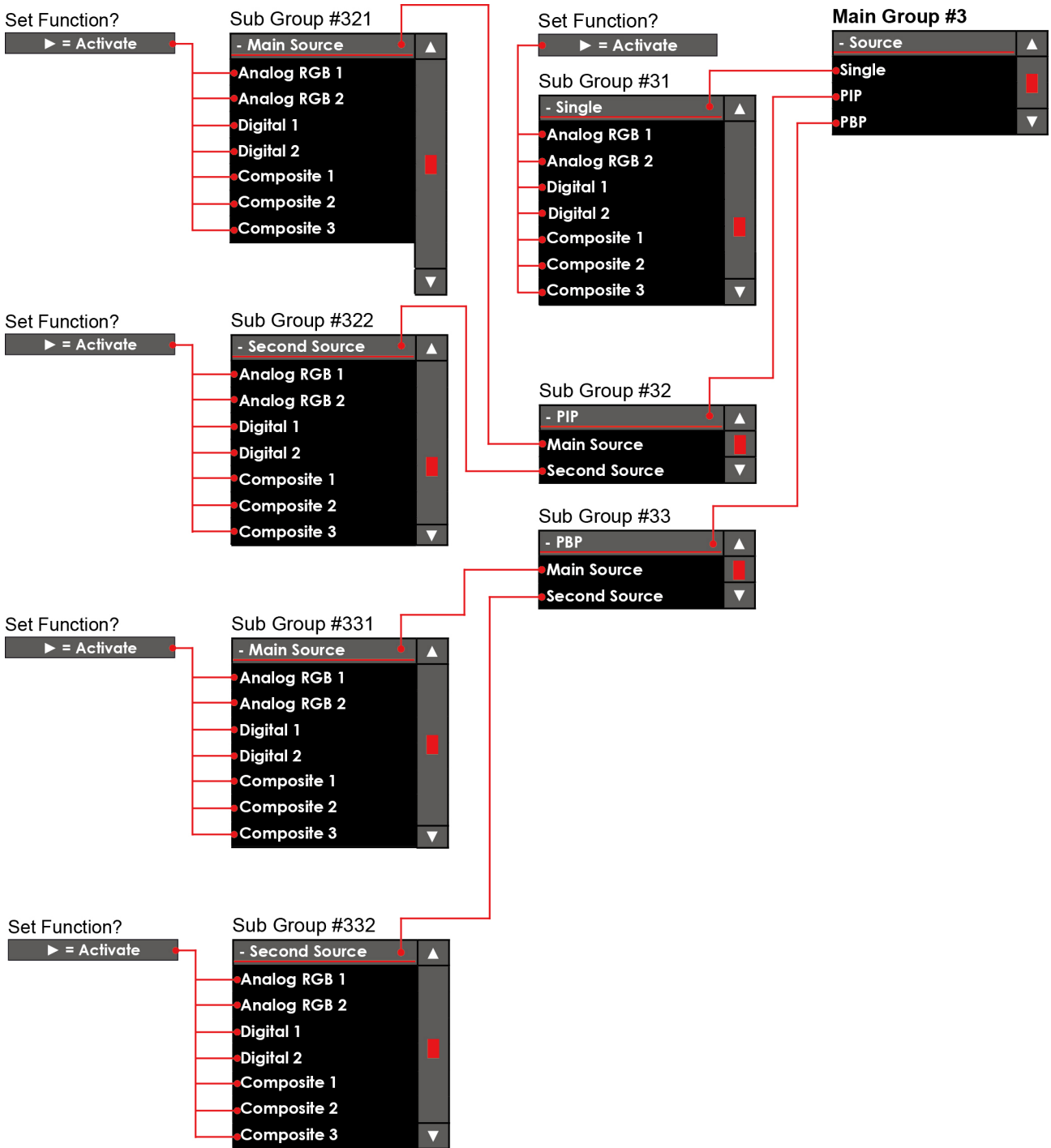

OSD Menu Items Explained

The following section explains all possible image properties that the user can encounter or adjust. The menu location of each item is described as a filetree path. Please review the **OSD Menu Map** earlier in this manual for an overview of the menu file structure. Most parameters may be adjusted in real time, so you do not need to exit the OSD menu to check results.

Note: For custom products and/or collaborative OSD software solutions, the menu properties listed here may deviate slightly from the OSD menu that has shipped with your product.

Basic Image Properties

Display-Picture-Brightness

This is only available in [Full Menu](#) mode.

Electronically increase/decrease the overall brightness of the panel by adjusting the voltage level.

This applies to the Main Source signal. **Window overlays (PIP/PBP)** and the **OSD Menu** overlay will be unaffected.

Scale is from 0-255. 160 is the default.

Display-Picture-Contrast

This is only available in [Full Menu](#) mode.

This increases/decreases the overall contrast of the panel electronically by controlling the voltage level.

This applies to the Main Source signal. **Window overlays (PIP/PBP)** and the **OSD Menu** overlay will be unaffected.

Scale is from 0-100. 50 is the default.

Display-Picture-Phase

This only applies to analog VGA/RGB signals. Can affect image quality.

This function will remove pixellation defects (particularly evident in black areas) that manifest as a vertical line from top to bottom by fine tuning signal data sampling.

Scale is from 0-100. Default is relative to signal source.

Display-Picture-Frequency

This only applies to analog VGA/RGB signals.

This adjusts the horizontal frequency of the analog signal to improve visibility of the entire image. When it is adjusted, you will notice that the image will appear to be stretched and might in some situations start to flicker/scroll, at which point you must reverse the last adjustment to stop it from flickering/scrolling anymore. This function can be used for older signals that are not automatically detected by the internal display controller.

Scale is from 0-200 steps. Default is relative to signal source.

Display-Picture-Sharpness

This increases/decreases the overall image sharpness. This affects the whole panel, and applies to all signal inputs and window overlays (PIP/PBP). Use it to increase the visual quality of signals from possible older equipment or electronically weak signals.

Scale is from 0-15 steps. 7 is default.

Display-Picture-Color

This only applies to video signals configured as the **Main Source**. This increases/decreases the overall color saturation, and can be used if incoming signals lack strong colors, as sometimes happens with older equipment or bad cables. Note that this function can also make noisy color signals appear crisper/clearer if color is rolled back closer to grayscale. The recommended levels are the factory default, which are set to a neutral and a normalized level.

Scale is from 0-100. 50 is the default.

Display-Picture-Tint

This only applies when analog Composite/S-VHS NTSC video signals have been configured as the **Main Source**. This increases/decreases the overall video tint. This will adjust all colors brighter or darker, making the image more "washed out" or stronger in terms of color intensity. This setting may be used if the incoming signal from older equipment or bad cabling lacks strong colors. The recommended level is the factory default, which is set to neutral.

Scale is from 0-100. 50 is the default.

Picture: PIP Adjustments

Display-Picture-PIP/PBP Adjust-PIP Size

To enable this function, please see **Display-Source-PIP-xxxx** and **Display-Source-PBP-xxx**, below. This increases/decreases the Picture-In-Picture window sizes. These functions will allow any of the signal inputs to be placed as a real time window overlay (or side by side if using PBP) on top of the current Main Source signal enabling the main feature of the Multi Display functionality.

Display-Picture-PIP/PBP Adjust/H Position

To enable this function, please see **Display-Source-PIP-xxxx** and **Display-Source-PBP-xxx**, below. This adjusts the horizontal (left/right) position of the real time window overlay.

Scale is from 0-100. 0 is default.

Display-Picture-PIP/PBP Adjust/V Position

To enable this function, please see **Display-Source-PIP-xxxx** and **Display-Source-PBP-xxx**, below. This adjusts the vertical (up/down) position of the real time window overlay.

Scale is from 0-100. 0 is default.

Display-Picture-PIP/PBP Adjust-PIP Picture-Brightness

To enable this function, please see **Display-Source-PIP-xxxx** and **Display-Source-PBP-xxx**, below. This increases/decreases the overall brightness of the window overlay. This will not change the brightness of the **Main Source** signal behind the window overlay. It can be used for situations where the incoming video signal from CCTV or other video sources appears dark in comparison to the source signal.

Scale is from 0-100. 50 is the default.

Display-Picture-PIP/PBP Adjust-PIP Picture-Contrast

To enable this function, please see **Display-Source-PIP-xxxx**, below.

This increases/decreases the overall contrast of the window overlay. This will not change the contrast of the **Main Source** signal behind the window overlay. It can be used for situations where the incoming video signal from CCTV or other video sources appears washed out in comparison to the source signal.

Scale is from 0-100. 50 is the default.

Display-Picture-PIP/PBP Adjust-PIP Picture-Sharpness

To enable this function, please see **Display-Source-PIP-xxxx**, below.

This increases/decreases the overall image sharpness. This will not change the sharpness of the Main Source signal behind the window overlay. Use it to increase the visual quality of signals from possible older equipment or electronically weak signals.

Scale is from 0-15 steps. 7 is default.

Display-Picture-PIP/PBP Adjust-PIP Picture-Color

This only applies to analog VIDEO IN signals.

To enable this function, please see **Display-Source-PIP-xxxx**, below.

This increases/decreases the overall color saturation for video signals. Can be used if the incoming signal lacks strong colors because it originates in older equipment, or is transmitted over bad cables. This will not change the color saturation/intensity of the **Main Source** signal behind the window overlay. Note that this function can also make noisy color signals appear crisper/clearer if the parameter is reduced towards the grayscale.

Scale is from 0-100. 50 is the default.

Display-Picture-PIP/PBP Adjust-PIP Picture-Tint

This only applies to analog VIDEO IN signals.

To enable this function, please see please see **Display-Source-PIP-xxxx**, below.

This increases/decreases the overall video tint (applies only for NTSC video signals.), making all colors brighter or darker. This may make the image appear washed out or stronger in terms of color intensity. Can be used if the incoming signal from older equipment or bad cables lacks strong colors. This will not change the color tint of the **Main Source** signal behind the window overlay.

Scale is from 0-100. 50 is the default.

Picture: Advanced Settings

Display-Picture-Adv Settings-Color Temperature- xx00K

This adjusts the overall color temperature, as measured in Kelvin degrees. You can choose between 9300K and 6500K. This applies to the Main Source signal. **Window overlays (PIP/PBP)** and the **OSD Menu** overlay will be unaffected. Lower values make the image appear warmer, while higher values will make it appear cooler. Default is set to 6500K. Please refer to the Kelvin color temperature scale below (approximate and symbolic):



When selected, a box icon (☐) will indicate that the selected function has been activated.

Display-Picture-Adv Settings-Color Temperature-User-RGB

This is only available in [Full Menu](#) mode.

This adjusts the color temperature manually. You can adjust the R (red), G (green) and B (blue) levels. This only applies to the **Main Source** signal. **Window overlays (PIP/PBP)** and the **OSD Menu** will be unaffected.

Press the right (▶) button to activate each R, G, B level and adjust them separately.

Display-Picture-Adv Settings-Graphic Scaling-One to One

This is only available in [Full Menu](#) mode.

This sets image scaling at 1:1. This means that the incoming signal is shown as is, without any scaling to fit the display area. The image will, however, be manipulated for its best fit (i.e., for widest possible or tallest possible display, according to whichever allows a complete display of the image with no loss of information). If the image appears to have black bars at top/bottom and/or left/right area then this means that the input image does not precisely match the aspect ratio of the display panel. Similarly, if the image is substantially smaller in size than the available screen area, this means that the original image resolution is substantially lower than that of the display panel.

When selected, a box icon (■) will indicate that the selected function has been activated.

Display-Picture-Adv Settings-Graphic Scaling-Fill Screen

This is only available in [Full Menu](#) mode.

This menu item sets the screen to adjust a **Main Source** input signal to fit the entire panel resolution, regardless of the image's native aspect ratio. This means that if the incoming signal is not coded for the panel's aspect ratio then the image will be distorted. If the image appears stretched or stilted after choosing the **Fill Screen** menu option, it is because the source image is improperly scaled to the display panel's aspect ratio. To adjust the image so that it is displayed to proper scale, adjust the image by selecting **Fill Aspect Ratio**; this will mean, however, that the image will not fill the panel's entire display area (i.e., the image will show black bars, or "dead space").

When selected, a box icon (■) will indicate that the selected function has been activated.

Display-Picture-Adv Settings-Graphic Scaling-Fill Aspect Ratio

This display property is the factory default.

This is only available in [Full Menu](#) mode & when an analog **DVI**, **VGA**, or **RGB** signal is selected as the **Main Source**.

This sets the display to present the image with a correct aspect ratio. This means that the incoming signal is scaled to the best possible fit within the entire display area, and if the image's aspect ratio is not perfectly compatible with the display panel's native aspect ratio then blank areas (black bars) will be visible at the top/bottom and/or sides. It is possible to utilize any dead space by configuring a PIP images to overlay the dead space; however, only **Composite** signal sources may be used in this manner (i.e., as secondary input sources, or **Second Source**). To implement this feature, please refer to the **Display-Source-PIP-xxxx** section, below.

When selected, a box icon (■) will indicate that the selected function has been activated.

Display-Picture-Adv Settings-Graphic Scaling-Anamorphic

This is only available in [Full Menu](#) mode and when analog **Composite/S-VHS** signals are set as **Main Source**.

If the display panel is displaying a widescreen image but is not a widescreen type then this parameter must be selected to prevent the image from being illegibly compressed by an incompatible aspect ratio.

By applying this aspect ratio, the display panel will re-scale the widescreen image to fit a 4:3 or 5:4 resolution.

Anamorphic widescreen scaling is a video technique that allows a widescreen picture to be displayed on a standard 4:3 (or 5:4) panel. The resulting image will not fill the entire display panel, leaving dead regions ("black bars") visible at the top and bottom of the display.

It is possible to utilize any dead space by configuring a PIP images to overlay the dead space; however, only

Composite signal sources may be used in this manner (i.e., as secondary input sources, or **Second Source**). To implement this feature, please refer to the **Display-Source-PIP-xxxx** section, below.

When selected, a box icon (■) will indicate that the selected function has been activated.

Display-Picture-Adv Settings-Graphic Scaling-Auto

This is only available in [Full Menu](#) mode and only when analog **Composite/S-VHS** signals are configured as the **Main Source**.

With this selection, the display controller will automatically try to identify the aspect ratio of the incoming signal and scale the source image to its proper aspect ratio, according to the best possible fit (i.e., for widest possible or tallest possible display, according to whichever allows a complete display of the image with no loss of information). Since this is an automatic and electronically intelligent function it may not work correctly with all signals. Users may be forced to choose one of the other graphic scaling techniques above to get the correct/desired image appearance.

When selected, a box icon (■) will indicate that the selected function has been activated.

Display-Picture-Adv Settings-Horz Position

Adjust the horizontal (left-to-right) position of the entire display area across the panel. This applies only to the **Main Source** signal. Please note that this function can move information in the image outside the visible display area, so use with caution.

Scale is from 0-100. 50 is the default.

Display-Picture-Adv Settings-Vert Position

Move the vertical (up-and-down) position of the panel's entire display area. This is only applied to the **Main Source** signal. Please note that this function can move image information outside the visible display area, so use caution.

Scale is from 0-100. 50 is the default.

Display-Picture-Adv Settings-RGB Calibrate

Warning! The displayed image **MUST** be a black/white image! Color images displayed as a gray scale are incompatible! If a gray scale image is used, the calibration will produce incorrect color values!

This is only available in [Full Menu](#) mode and when analog **VGA/RGB** signal are selected as the **Main Source**. This function will automatically recalibrate the gain on the R(red), G(green), and B(blue) signals (also known as "color intensity") to a neutral, normalized level.

This function will override any previous color adjustments selected from the OSD menu, including Kelvin color temperature settings. This adjustment only affects the **Main Source** signal.

Press the right (▶) button to activate. A confirmation dialog will appear. Use

↑ / ↓ to confirm.

Swap Input Sources: Main to Second / Second to Main

Display-Picture-Swap Source

This function will only be available if **PIP/PBP** is on; to set this property, please refer **Display-Source-PIP-xxxx** and **Display-Source-PBP-xxx**, below.

This function swaps the source priority of the full screen and window overlay images, transferring the overlay image into the **Main Source** priority, and the full screen ("Main Source") image into the **Second Source** (PIP/PBP) priority. It will transfer these images according to whatever signal inputs have been set as **Main Source** and **Second Source**.

Press the right (▶) button to activate this function. The OSD menu will still be visible.

Image Information

Display-Picture-Picture Info-Main Source

Please note that a valid **Main Source** input signal must be present for this selection to work.

This item only displays all the information regarding the **Main Source** signal. The information displayed includes the physical port and input name (software), current signal resolution, horizontal frequency (h-freq), and vertical frequency (v-freq).

This item will not perform any changes or adjustments to the display settings and signals.

When selected, a box icon (■) will indicate that the selected function has been activated.

Display-Picture-Picture Info-Second Source

Please note that a valid **Second Source** input signal must be present for this function to work.

This item only displays all the information regarding the **Second Source** signal. The information displayed includes the physical port and input name (software), current signal resolution, horizontal frequency (h-freq), and vertical frequency (v-freq).

This item will not perform any changes or adjustments to the display settings and signals.

When selected, a box icon (■) will indicate that the selected function has been activated.

Auto-Setup

Display-Picture-Auto Setup

This is only available when the **Main Source** is set to an analog **VGA/RGB** signal, and a DVI signal.

This function will analyze the incoming source signal and attempt to auto-adjust the displayed image to correct for improper aspect ratio, off-centered images, and improper phase or frequency (for analog signals). An attempt will be made to reset all signals, but this will not affect the **OSD Menu** configuration or similar user settings.

This function may be used in cases where you suspect display issues have been introduced by faulty or unsuitable configuration. It can also be used when troubleshooting set ups to determine if the reason for a faulty or undesirable image is the cause of a panel malfunction, a mis-configuration, or from external equipment.

Press the right (▶) button to activate. A confirmation request will appear. Use ↑/↓ to confirm.

Display Setup: OSD

Display-Setup-OSD Settings-Language

This function will choose the default language to use in all **OSD Menu** messages. The only language currently available is English.

Display-Setup-OSD Settings-OSD Timeout (sec)

This increases/decreases the **OSD Menu**'s automatic timeout period (the time before the overlay automatically disappears without the user having to manually exit).

Scale is from 5-30 seconds. 20 is default.

Display-Setup-OSD Settings-Transparency

This increases/decreases the alpha blend (also known as transparency) of the **OSD Menu**. When increased to maximum, this means that all signal inputs and PIP/PBP images will show through the OSD Menu. It is used when

important information on the display must be visible at all times. A black border around the OSD menu layout will always be black and is not affected by this adjustment.

Scale is from 0-100. 50 is the default.

Display-Setup-OSD Settings-OSD Horz Position

Moves the horizontal (left/right) position of the **OSD Menu**. The OSD can only be moved within the available display area.

Scale is from 0-100. 100 is default.

Display-Setup-OSD Settings-OSD Vert Position

Move the vertical (left/right) position of the **OSD Menu** overlay. The OSD can only be moved within the available display area.

Scale is from 0-100. 100 is default.

Display-Setup-OSD Settings-Full Menu

This is only available after the administrator password has been entered.

If the **Simplified** OSD mode is insufficient for your purposes, you may gain access to all possible display parameters by following this procedure:

- Press the right arrow (▶) to activate this function
- A data entry dialog will appear, with 3 digits shown, each defaulting to zero (0 0 0).
- To enable **Full Menu** mode, change the 3 digits to **158**, then
- Press the right arrow (▶) to confirm.

Now all menu functions will be accessible. When you power off the product, this setting will revert back to **Simplified** mode.

Note: To force the OSD Menu to always appear in full menu mode, you must first unlock the OSD Menu with the procedure as described and then navigate the OSD menu to **Display-Setup-OSD Settings-OSD Mode-Full** where you may activate the **Full Menu** setting as default.

Display-Setup-OSD Settings-OSD Mode-Simplified

Simplified Mode is the factory default.

This setting only appears when the display is in **Full Menu** mode.

This selection forces the **OSD Menu** to always appear in **Simplified Mode** (even after power shutdown of the unit). This means that a lot of advanced functions will not be accessible from the OSD menu. Setting the OSD to simplified mode is to prevent advanced changes to the display that could profoundly affect display functionality and/or image quality. Only experienced and qualified personnel should access and change this setting.

When selected, a box icon (■) will indicate that the selected function has been activated.

Display-Setup-OSD Settings-OSD Mode-Full

This is only available in **Full Menu** mode.

Force the **OSD Menu** to always appear in **Full Menu** mode (even when powering on after a shutdown of the unit).

This means that all possible display functions will be accessible from the **OSD Menu**.

Only experienced and qualified personnel should access and change this setting.

When selected, a box icon (■) will indicate that the selected function has been activated.

Display-Setup-OSD Settings-Lock Mode-Normal

This is only available in [Full Menu](#) mode.

This unlocks the **OSD Menu** so that users may access it without any password protection.

When selected, a box icon (■) will indicate that the selected function has been activated.

Display-Setup-OSD Settings-Lock Mode-Password Protect

This is only available in [Full Menu](#) mode.

When the **OSD Menu** is set to **Password Protect**, users will need to enter a password before access to the **OSD Menu** (image properties dialog) is granted.

When **Password Protect** is set, any user who presses **MENU** will first be directed to a password entry dialog, which will display 3 zeroes as default (**0 0 0**).

To enter the **OSD Menu**, use the up and down arrows to input **321** and then press the right arrow (▶) to confirm. Password protection will remain active even after powering down; to gain access, the same password will continue to be required until **Display-Setup-OSD Settings-Lock Mode-Normal** is reset.

When selected, a box icon (■) will indicate that the selected function has been activated.

Display Setup: User Settings

Display-Setup-User Settings-DPMS

This enables/disables the VESA Display Power Management Signaling (DPMS) function. DPMS is a standard established by the VESA Consortium that enables intelligent power management of computer display units via the graphics card. DPMS allows the panel to save power by decreasing or cutting off power after the display has sat idle for a specified period of time. The default setting is **Enable DPMS (On)**.

When selected, a box icon (■) will indicate that the selected function has been activated.

Display-Setup-User Settings-Communication-RS-232

This is only available in [Full Menu](#) mode.

This item sets the built-in serial port to the RS-232 protocol, enabling serial communications control via an RS-232 interface; i.e., the MD-119 may use the serial port to serve as the DTE of a remote DCE.

This setting enables operators to modify a wide range of the display controller's internal parameters. Daisy-chain operation is also possible if the DCE is equipped with a second COM port.

When selected, a box icon (■) will indicate that the selected function has been activated.

Display-Setup-User Settings-Communication-2-wire RS-485

This is only available in [Full Menu](#) mode.

This setting configures the built-in serial port as a 2 wire RS-485 interface, enabling control serial devices over an RS-485 serial network.

When selected, a box icon (■) will indicate that the selected function has been activated.

Display-Setup-User Settings-Communication-4-wire RS-485/RS-422

This is only available in [Full Menu](#) mode.

This setting configures the built-in serial port as a 4 wire RS-485 interface, enabling control of serial devices over an RS-485 serial network.

When selected, a box icon (■) will indicate that the selected function has been activated.

Display-Setup-User Settings-Communication-Address

This is a feature for configuring a serial interface that is only available in [Full Menu](#) mode.

This menu item allows the user to set a UART address for device identification on an RS-485 or RS-422 serial network.

Level adjust from 0-15 and reflects a unique ID number. Default is 0.

Display-Setup-User Settings-Splash Screen

This is only available in [Full Menu](#) mode.

This setting enables/disables the **Splash Screen Logo** when the unit is powered on, for as long as the display controller is initializing. The logo will disappear once the signal input appears on-screen. By factory default, the splash shown is the Moxa logo. Please contact our customer support representatives for information on splash screen customization.

Display Setup: Preset Defaults

Display-Setup-Load Default-Factory Default

This function will reset all settings to their factory defaults; for information on resetting the system to a set of saved **User Defaults**, please refer to **Display-Setup-Load Default-Load User Default**, below. All signal inputs and image adjustments will be reset. This function may be used in cases where you suspect a display configuration is causing system faults. It can also be used when trouble-shooting configurations to determine if the display is the reason for an undesirable effect, or if the problem is originating in external equipment.

Press the right (▶) button to activate. A confirmation dialog will appear. Use ↑/↓ to confirm.

Display-Setup-Load Default-Load User Default

This function will restore any **User Default** settings that have been previously saved (to learn how to save a **User Default** configuration, see **Display-Setup-Load Default/Save User Default**, just below). If no **User Default** configuration is found, nothing will be re-configured. User defaults are custom display properties that have been adjusted and saved by the user. This feature may be used when trouble-shooting configurations to determine if the display is the cause of a faulty or undesirable effect, or if problems are originating in external equipment.

Press the right (▶) button to activate. A confirmation dialog will appear. Use ↑/↓ to confirm.

Display-Setup-Load Default-Save User Default

This is only available in [Full Menu](#) mode.

This function will create and save a custom **User Default** configuration. A set of user defaults consists of the device's current set of display parameters as defined by the user via the **OSD Menu**. Saving a set of user-defined defaults provides an alternative and completely independent configuration to the **Factory Default**. It is useful for customers who want to specifically preset the **OSD Menu** according to a company's networking or device policies and specifications.

To learn how to restore a saved User Default configuration, please refer to **Display-Setup-Load Default/Load User Default**, just above.

Press the right (▶) button to activate. A confirmation dialog will appear. Use ↑/↓ to confirm.

Display-Setup-Direct Access (right/left arrow hotkeys)

This menu item allows the user to configure the right and left arrows to as "hotkeys" that directly access display properties that users often find themselves fine-tuning, giving more convenient access to features that are otherwise only accessible by navigating the **OSD Menu** in depth. Available assignment is **Brightness, PIP Size,**

Main Source, Second Source, Swap Source. The assignment **No Function** eliminates all hotkey assignments for the right/left arrows, leaving them (per default) only effective when the **OSD Menu** is activated.

When selected, a box icon (■) will indicate that the selected function has been activated.

Display Setup: Service Menu

Display-Setup-Service Menu-Type and Serial

This is only available in [Full Menu](#) mode.

This menu item reports the display unit's **model** and **serial number**. This information is stored electronically, on-board. Example: **MD-119ABCD12345678**: the model number forms the first five numbers, and the remaining digits form the serial number.

Display-Setup-Service Menu-Firmware Ver

This is only available in [Full Menu](#) mode.

This menu item reports the device's firmware version. Firmware updates may only be undertaken by a Moxa engineer. If a firmware revision or customization is required, please contact Moxa's customer support to learn about our Professional Design Service (PDS).

Example: "V.10 S15".

Display-Setup-Service Menu-Elapsed Time (Hours)

This is only available in [Full Menu](#) mode.

This function reports the total hours the display panel has been running since it was first installed; this is not the same as how long the display has been powered up: the total time spent displaying an image since installation is reported, and only time spent actually displaying an image is included. With reference to the device's MTBF, this menu item may be used to calculate the remaining life span of the device.

As an example, if the number **452** is displayed, here, then the device has been displaying images for a total of 452 hours.

Display: Input Sources / Dual Image Displays

Display-Source-Single-xxx

This menu item allows users to configure the display to display a single, solitary source input, without any picture-in-a-picture or picture-by-a-picture configuration.

After navigating to **Display/Source**, upon selecting **Single** from the menu offered you will be transferred to a submenu from which you may then select which signal source should be configured as the sole input signal to be displayed. A small, square icon (■) will appear next to whichever menu item is selected to indicate the currently configured signal source.

Whichever source is selected as the single display will automatically be configured as the **Main Source**. This means that, should the **Swap Source** feature be selected, the input source configured through the

Display-Source-Single function will be switched out with whichever composite input signal (Composite 1, 2, or 3) has been configured as the **Second Source**. Consequently, because the display controller has been previously configured for **Single** mode, the currently configured **Main Source** image will disappear and be replaced with the **Second Source** (which will become the new **Main Source**). To return the device to its original configuration, simply select **Swap Source** once again and the display controller will return to its original display configuration. Choosing "single" will display only the input signal that has been configured as **Main Source**.

To change the signal source that is used in single mode, navigate into the submenu as before (i.e., by using the right arrow to select **Single** from within the **Display/Source** menu) and choose which input signal should be prioritized as the **Main Source**.

Choosing **Single** while the display is operating in **PIP** or **PBP** mode will stop the device from displaying any and all **Second Source** images return it to displaying only the single **Main Source** image.

When selected, a box icon (■) will indicate that the selected function has been activated.

Display-Source-PIP-xxx

This menu item allows users to configure the display controller to display a **Second Source** signal input to be displayed as a picture-in-a-picture (PIP, or POP).

*Only composite signals may be configured as PIP images, and only a total of two images (i.e., **either** a single PIP **or** a single PBP, but not both and not more than one) may be displayed at any given time.*

After navigating to **Display/Source**, selecting **PIP** from the menu will open a submenu from which you may select a **Composite** signal source should be configured as the **Second Source** input signal.

*Only **Composite** signals may be selected as **Second Source** inputs. Digital and RGB signals may not be used as a secondary input source.*

A small, square icon (■) will appear next to whichever menu item is selected to indicate the currently configured signal source. This input will then be displayed within a small, configurable box superimposed over the **Main Source** image.

The dimensions and image properties of the PIP are configured from within the OSD. Navigate to the **Display-Picture-PIP-PBP Adjustment** menu. From there, the PIP may be adjusted for horizontal and vertical positioning, size, and display properties.

*It is possible to use PIP images to fill "dead space" left by **Main Source** displays whose aspect scaling does not fill the entire wide-screen panel ratio by configuring the PIP's size and positioning to overlay any black bars/space produced by image scales which do not completely fill the screen.*

Should the **Swap Source** feature be selected, the input source (whether digital, RGB, or composite) configured as the **Main Source** will be immediately switched out with the composite input signal currently configured as a PIP. To return the device to its original configuration, simply select **Swap Source** once again and the display controller will return to its original display configuration.

If, after configuring a PIP, the menu item **Display-Source-Single** is activated then the PIP will disappear, leaving only the **Main Source** input signal as a solitary display.

When selected, a box icon (■) will indicate that the selected function has been activated.

Display-Source-PBP-xxx

This menu item allows users to configure the display controller to display a **Second Source** signal input as a picture-beside-a-picture (PBP).

*Only composite signals may be configured as PBP images, and only a total of two images may be displayed at any given time; i.e., a **Main Source** image may also display **either** a single PIP **or** a single PBP, but not both and not more than one additional image.*

After navigating to **Display/Source** and selecting **PBP** from the menu, a submenu will open from which you may select a **Composite** signal source to be configured as the **Second Source** input signal.

*Only **Composite** signals may be selected as **Second Source** inputs. Digital and RGB signals may not be used as a secondary input source.*

A small, square icon (■) will appear next to whichever menu item is selected to indicate the currently configured signal source. This input will then be displayed beside the **Main Source**, with each image sharing a full half of the panel display. Aspect ratios for each image will be recalculated according to the new screen space, and may need to be manually re-adjusted.

To adjust the PBP's display properties, navigate to the **Display-Picture-PIP-PBP Adjustment-PIP Picture** menu. From there, the PBP's image properties (**Brightness, Contrast, Sharpness, and Color**) may be adjusted.

The dimensions and positioning of the PBP are not adjustable.

Should the **Swap Source** feature be selected, the input source (whether digital, RGB, or composite) configured as the **Main Source** will be immediately switched out with the composite input signal currently configured as the PBP. In PBP display mode, this will transfer the right image into the left position, and the left image into the right; however, should the user attempt to return to **Single** mode from this configuration, the **Composite** input (currently

selected as the **Main Source**) will be displayed as the main image. To return the display to its original configuration, simply select **Swap Source** once again and the display controller will return to its original display configuration. If, after configuring a PBP, the menu item **Display-Source-Single** is activated (and the **Swap Source** function has not been activated) then the PBP will disappear, leaving only the **Main Source** input signal as a solitary display. **When selected, a box icon (■) will indicate that the selected function has been activated.**

Power Off

Display-Power Off

This function will perform a (soft) power down (i.e., turns off) the unit, shutting down the display controller and cutting internal power to all components except the power module. When power is shut off the unit will enter standby mode, whereupon the red, left-most LED will illuminate, while the green, right-most LED will go dark. ***Please note that so long as the power cable is still physically connected to the power module power will still be present in the unit.***

Press the right (▶) button to activate. A confirmation dialog will appear. Use ↑/↓ to confirm.

Display UART Command

This chapter defines the serial data format and the serial communication protocol so that engineers can use them to program the communication between their computers and the MD-119 display.

The following topics are covered in this appendix:

- ❑ **Connecting to the Display**
- ❑ **UART Software Configuration**
 - Date Rate
 - Data Format
- ❑ **UART Command Format**
 - Command Format Description
- ❑ **Downloading Files**
 - Downloading Files
 - Downloading Dual RGB File
 - Uploading/Downloading Configuration Files
- ❑ **OSD Control Command**
 - BLI (Brightness Control)
 - DST (Display State)
 - MAN (Manufacturer ID Code)
 - POT (Potentiometer Control)
 - SNB (Serial Number Query)
 - TYP (Type/Model/Number Query)
 - SWI (Software Version Query)
 - VER (Version Number)
 - MCC (OSD Control)
- ❑ **MCC Control Command**

Connecting to the Display

You need to use a serial cable to connect the computer to the serial port, marked RS-232/422/485 on the MD-119 display. Then you can use the program to communicate with the MD-119.

UART Software Configuration

Date Rate

The date rate has been set at 9600 bits/second for data transmission and receive.

Data Format

Data shall be transmitted with no parity, 8 data bits, 1 start bit, and 1 stop bit.

UART Command Format

The basic message format is listed below:

Byte #	0	1	2,3,4	5	6	7, etc	7+LEN
	ATTN	ADDR	CMD	LEN	IHCHK	DATA	IDCHK

The minimal message size is 7 bytes, and the maximal message size is 82 bytes, consistent with 61162-1.

Command Format Description

ATTN (Attention)

This byte is used to identify a start of message, and it can be one of three values:

ATTN	Description
0x07	Command (ASCII BELL)
0x06	Acknowledge (ASCII ACK)
0x15	Negative Acknowledge (ASCII NAK)

A device shall send a command using the 0x07 Attention Code. The unit will respond to the command with either an ACK if the command completed successfully, or a NAK if the command failed.

ADDR (Address)

This byte is used to specify a particular unit to receive a Command and to identify the unit responding (ACK or NAK) to a Command. All units will support the broadcast address. The factory default address is 0.

The Address field shall have the following values:

ADDR	Description
0xFF	Broadcast - Addressed to all units
0x00 to 0x0F	Address of a specific unit (max of 16 units)

CMD (Message Commands and Queries)

The command can be one of the following values:

CMD 0	CMD 1	CMD 2	ASCII	Description
0x42	0x4C	0x49	"BLI"	Brightness Control
0x45	0x54	0x43	"ETC"	Elapsed Time Counter Query
0x44	0x53	0x54	"DST"	Display State
0x4D	0x41	0x4E	"MAN"	Manufacturer ID Code
0x4D	0x43	0x43	"MCC"	OSD Control
0x50	0x4F	0x54	"POT"	Potentiometer Control
0x53	0x4E	0x42	"SNB"	Serial Number Query
0x53	0x57	0x49	"SWI"	Software Version Query
0x54	0x59	0x50	"TYP"	Type/Model Number Query
0x56	0x45	0x52	"VER"	ID Version Number Query

LEN (Data Length)

This byte defines the length of data in the message in bytes. The maximal value for this field is 74 bytes, and the minimal value is 0 byte.

IHCHK (Inverse Header Checksum)

This is a simple 8-bit checksum of the header data, message bytes 0 to 5 on which a bit-wise inversion has been performed. The checksum should be initialized to 0. The 8-bit sum (without carry) of bytes 0, 1, 2, 3, 4, 5, and 6 shall be 0xFF.

If a message is received with an incorrect checksum, the display will replay with the attention code set to NAK and no data field. This does not apply to Broadcast messages in RS-485 mode, in which case there will be no reply.

DATA (Data Field)

The data field shall only be transmitted if LEN is larger than 0. This field depends on the CMD transmitted.

IDCHK (Inverse Data Checksum)

These bytes shall be only transmitted if LEN is larger than 0. This is a simple 8-bit checksum of the data field, message bytes 7 to 7+(LEN-1) on which a bit-wise inversion has been performed. The checksum shall be initialized to 0. The 8-bit sum (without carry) of bytes 7 through 7+LEN inclusive shall be 0xFF. The receiver will

reply to any message that the checksum has failed with the attention code set to NAK. This requirement does not reply to broadcast messages in RS-485 mode, in which case there will be no reply.

Downloading Files

Downloading Files

Use the following commands for downloading files.

Commands	Description
DL?	Data: none (0 byte) ACK: Total packet numbers (1 byte)
DLN	Data: Appointed packet (1 byte) ACK: File content (72 bytes maximum, except for the last packet)

The command **DL?** will send a request to the micro controller and ask how many packets that need to be downloaded. The reply from the micro controller shall be used when using the command DLN to download the specific packets.

Command DL?

Byte Number	Byte 0	Byte 1	Byte 2	Byte 3	Byte 4	Byte 5	Byte 6
Hex	0x7	0xFF	0x44	0x4C	0x3F	0x0	0x2A
ASCII			D	L	?		

Command DLN

Byte Number	Byte 0	Byte 1	Byte 2	Byte 3	Byte 4	Byte 5	Byte 6	Byte 7	Byte 8
Hex	0x7	0xFF	0x44	0x4C	0x4E	0x1	0x1A	0x50	0xAF
ASCII			D	L	N				

Downloading Dual RGB File

Use the following commands for downloading dual RGB file.

Commands	Description
D2?	Data: none (0 byte) ACK: Total packet numbers (1 byte)
D2N	Data: Appointed packet (1 byte) ACK: File content (72 bytes maximum, except for the last packet)

Uploading/Downloading Configuration Files

Uploading

Use the following command for uploading the configuration files:

Commands	Description
UCF	No data packet, no response When the command is performed, wait for the configuration files to be transmitted from the computer to the display through Xmodem-CRC.

Downloading

Use the following command for downloading the configuration files:

Commands	Description
DCF	No data packet, no response When the command is performed, wait for the configuration files to be received from the display to the computer through Xmodem-CRC.

OSD Control Command

This section describes the OSD control commands that can be used to configure the display. See the following tables.

BLI (Brightness Control)

This command is sent to the unit to command the backlight brightness control setting. The brightness value shall be sent as one byte in the DATA field. A setting of 0x00 will indicate off. A setting of 0xFF will indicate maximum brightness. Intermediate values will control brightness over the range from minimum to maximum luminance.

LEN = one data byte.

Examples:

Command Brightness= 153

0x07	0xFF	0x42	0x52	0x54	0x01	0x10	0x99	0x66
------	------	------	------	------	------	------	------	------

Acknowledge Brightness= 153

0x06	0xFF	0x42	0x52	0x54	0x01	0x11	0x99	0x66
------	------	------	------	------	------	------	------	------

Negative Acknowledge Brightness= 102

0x15	0xFF	0x42	0x52	0x54	0x01	0x02	0x66	0x99
------	------	------	------	------	------	------	------	------

DST (Display State)

This command is sent to the unit to control the unit on/off or query the on/off state of the unit.

LEN = one data byte.

0x00	Turn the display off
0xFF	Turn the display on
0x3F	"?" - Query the state of the unit. The returned DATA field will indicate the state. 0x00 = Unit is off. 0xFF = Display is on.

If the data checksum is valid, the unit will reply to this command with an ACK attention code. The DATA field will indicate the unit state. If an invalid data checksum was received and the message was not broadcast and RS-485, the unit will reply with a NAK attention code and the current state.

MAN (Manufacturer ID Code)

This command is sent to the unit to request Manufacturer ID. No data shall be sent with this command. The unit will reply to this command with an ACK attention code. The DATA field identifies the manufacturer in a text string.

Examples:

Query Manufacturer ID:

0x07	0xFF	0x4D	0x41	0x4E	0x00	0x1D
------	------	------	------	------	------	------

Acknowledge Manufacturer ID "MOXA":

0x06	0xFF	0x4D	0x41	0x4E	0x0C	0x12	0x4D	0x4F	0x58	0x41
0x20	0x20	0x20	0x20	0x20	0x20	0x20	0x20	0x20	0x20	0x20

POT (Potentiometer Control)

The unit may allow the backlight to be controlled by the local control (potentiometer/keypad) mounted on the front of the unit, by the remote control or by the combination of the two. This command provides means to enable/disable the local control. LEN = one data byte.

0x00	Disables the local control. Backlight controlled only by the remote control.
0xFF	Enables the local control. Backlight is controlled by both the remote control and the local control. (Default) Note: In this setting, with the BRT command at 100%, the local control will have full dimming range. This is the initial setting when a unit is powered on.

If the data checksum is valid, the unit will reply to this command with an ACK attention code. The DATA field will indicate the resulting control setting. If an invalid data checksum was received and the message was not broadcast and RS-485, the unit will reply with a NAK attention code and the current control setting.

SNB (Serial Number Query)

This query is sent to the unit in order to identify the unit serial number. No data shall be sent with this query.

The display will reply to this command with an ACK attention code. The DATA field will be set to a text string to indicate the specified Serial Number, e.g: "12345".

Examples:

Command Display Serial Number

0x07	0xFF	0x53	0x4E	0x42	0x00	0x16
------	------	------	------	------	------	------

Acknowledge Type/Model Number "12345":

0x06	0xFF	0x53	0x4E	0x42	0x05	0x12
------	------	------	------	------	------	------

0x31	0x32	0x33	0x34	0x35	0x00
------	------	------	------	------	------

TYP (Type/Model/Number Query)

This query is sent to the display in order to identify the unit type by its model number / part number. No data shall be sent with this query.

The display will reply to this command with an ACK attention code. The DATA field will be set to a text string to indicate the specified Type/Model Number, e.g: "MD-119-TN".

Examples:

Command Type/Model Number

0x07	0xFF	0x54	0x59	0x50	0x00	0xFC
------	------	------	------	------	------	------

Acknowledge Type/Model Number "MD-119-TN":

0x06	0xFF	0x54	0x59	0x50	0x0C	0xF1
0x4D	0x44	0x2D	0x31	0x31	0x39	0x2D
0x54	0x4E	0x20	0x20	0x20	0x77	

SWI (Software Version Query)

This query is sent to the unit in order to get the software version ID. Any future revisions, such as CMD additions or changes to the software will increment the software version. The unit will reply to this command with an ACK attention code. The DATA field will be a text string indicating the software version.

Examples:

Command software query:

0x07	0xFF	0x53	0x57	0x49	0x00	0x06
------	------	------	------	------	------	------

Acknowledge software version "v1.0 s15"

0x06	0xFF	0x53	0x57	0x49	0x0C	0xFB	0x56	0x31	0x2E	0x30
0x20	0x20	0x20	0x20	0x20	0x53	0x31	0x35	0xC1		

VER (Version Number)

This query is sent to the unit in order to identify unit type by a pre-assigned code and establish the version of the serial communications interface software. No data shall be sent with this query.

Any future revisions, such as additions or changes to the commands or data fields, shall increment the unit Version Number. The unit will reply to this command with an ACK attention code. The DATA field has a unique 1-byte unit model code. The next 2 bytes shall contain major and minor version of the serial communication protocol in use.

Examples:

Command Unit Model/Version Number:

0x07	0xFF	0x56	0x45	0x52	0x00	0x0C
------	------	------	------	------	------	------

Version 1.2:

0x06	0x00	0x56	0x45	0x52	0x03	0x09	0x01	0x01	0x02	0xFB
------	------	------	------	------	------	------	------	------	------	------

MCC (OSD Control)

This command gives remote access to the display OSD menu settings. The commands are transmitted in the DATA field. See the appendix for a complete list of OSD commands. For future products, it can not be guaranteed that all commands will still be available.

If the checksum is valid, the unit will reply to this command with an ACK attention code, where the data field contains the original command followed by acknowledge from the controller, as described in the appendix. If the checksum is invalid and the message was not broadcast and RS-485, the unit will reply to this command with a NAK attention code, where the data field contains the original command.

Examples:

Command 50% contrast 0x82

0x41 0x33 0x32: (50% = 0x32. In

ASCII 32 will be: 0x33 0x32)

0x07	0xFF	0x4D	0x43	0x43	0x04	0x22
------	------	------	------	------	------	------

0x82	0x41	0x33	0x32	0xD7
------	------	------	------	------

Acknowledge 50% Contrast:

0x06	0x03	0x4D	0x43	0x43	0x06	0x1D
0x82	0x41	0x33	0x32	0x33	0x32	0x72

For more MCC control commands, see the next section.

MCC Control Command

This section describes the MCC control commands that can be used to configure the display.

See the following tables.

Function	Command	Description	Acknowledge (if enabled)
Contrast control - all channels	0x82, "?" "+", "-"	Set all contrast = value/increment/decrement Reset Query	Contrast red Range: "0" "0" - "6" "4" Default: "3" "2"
Sharpness	0x8a, "?" "+", "-"	Set sharpness = value/increment/decrement Reset Query	Sharpness. Range: "0" "0" - "0" "F" Default: "0" "7"
Input main select	0x98, "?" "nn"	Select input main = PC or VIDEO or next available Reset Query	Main selected. "0x41,0x31" ARGB1 (Default) "0x41,0x32"
Source Layout	0x9a, n "?"	Select source layout = Single, PIP or PBP Reset Query	Query: "0" - Single (default) "1" - PIP "2" - PBP
Power Down / DPMS Option	"0" "1" "?"	Set power down option = On/Off Reset Query	"0" - off "1" - on
Second source select	0xa7, nn "?"	Select input second = Video source value Reset Query	Main selected. "0x41,0x31" ARGB1 (Default) "0x41,0x32" ARGB2 "0x42,0x31" Composite1 "0x42,0x32" Composite2 "0x42,0x33" Composite3 "0x43,0x31" S-video1 "0x43,0x32" S-video2 "0x43,0x33" S-video3 "0x46,0x31" DVI
Auto-setup	0xc3	Auto-setup. (PC only)	"0" - fail. "1" - successful.

Auto-calibration	0xc5	Start auto-calibration of gain of the RGB amplifier.	"0" – fail. "1" – successful.
------------------	------	--	----------------------------------