

# MOUNT KITS

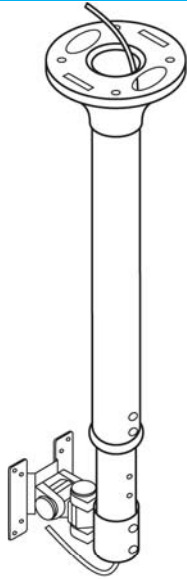

## Ceiling Pole Mount GPU-8730B

- Adjustable length: 600 mm to 1060 mm
- Adjustable screen tilt, swivel & rotate
- Firmly fixes on the ceiling
- Holds POS/monitor up to total weight of 20 kg
- VESA 75 x 75 / 100 x 100 mm

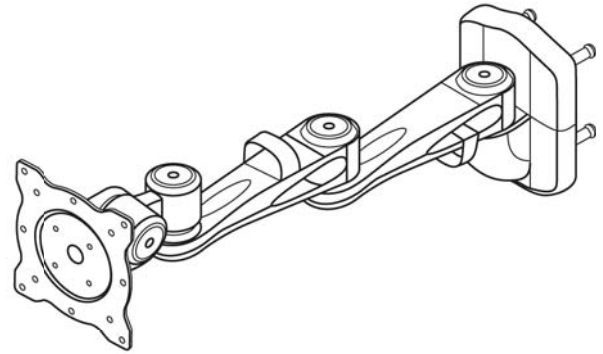

## Swing Arm GPU-262BS

- Mount POS/monitor onto the wall with a 45 cm long adjustable aluminium die-cast arm
- Adjustable screen tilt, swivel & rotate
- Holds POS/monitor up to total weight of 15 kg
- VESA 75 x 75 / 100 x 100 mm

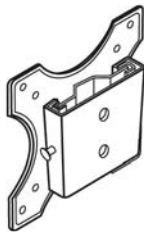

## Wall Mount bracket (flat) GPU-1150C

- Thin wall mounting (15 mm from wall)
- Firmly fixes onto the wall
- Holds POS/monitor up to total weight of 12 kg
- VESA 75 x 75 / 100 x 100 mm

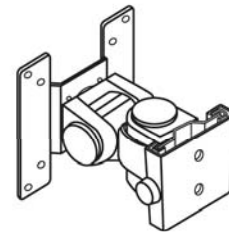

## Wall Mount bracket GPU-WM117B

- Deluxe wall mounting (130 mm from wall)
- Adjustable screen tilt, swivel & rotate
- Firmly fixes onto the wall
- Holds POS/monitor up to total weight of 12 kg
- VESA 75 x 75 / 100 x 100 mm

### The Senor Building

65 & 67 Weaver Street  
Coopers Plains  
QLD 4108, Australia

[www.senortech.com.au](http://www.senortech.com.au)

P: +61 7 3275 5888  
F: +61 7 3275 5800  
[sales@senortech.com.au](mailto:sales@senortech.com.au)

**SENIOR**  
TOUCH SCREEN SOLUTIONS

**Quality. Safety. Versatility.**

# MOUNT KITS

**Max Mount Pole**  
total length: 600 mm

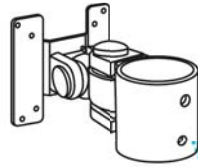

**Main Screen Bracket**  
Adjustment: tilt, swivel & rotate  
66B-400



**Main Screen Bracket**  
Adjustment: tilt, rotate  
61B-200



**Top-tilt Bracket**  
Adjustment: tilt, rotate  
61B-100

**Vertical Printer Carrier**  
Adjustment: tilt, rotate  
61B-200P

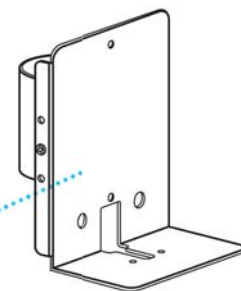
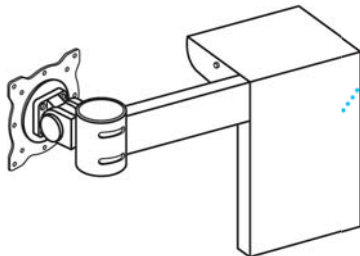

**Scanner Carrier**  
61B-300

**Keyboard Holder**  
61B-499



**Horizontal Printer Carrier**  
61B-300PL (left)  
61B-300PR (right)

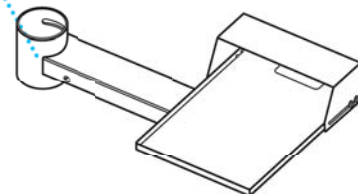

## The Senor Building

65 & 67 Weaver Street  
Coopers Plains  
QLD 4108, Australia

[www.senortech.com.au](http://www.senortech.com.au)

P: +61 7 3275 5888  
F: +61 7 3275 5800  
[sales@senortech.com.au](mailto:sales@senortech.com.au)

**SENIOR**  
TOUCH SCREEN SOLUTIONS

**Quality. Safety. Versatility.**