

DRPC-140-EHL

■ Fanless DIN-Rail Embedded System

Features

- Fanless system
- Intel® Celeron® J6412 2.0 GHz (up to 2.6 GHz, quad-core, TDP 10W)
- Four RS232/422/485 Serial port
- Two isolation CAN Bus interface
- CE/FCC compliant



Specifications

Model Name		DRPC-140-EHL
Chassis	Color	Black
	Dimensions (WxDxH)(mm)	58.75 x 130 x 174
	System Fan	Fanless
	Chassis Construction	Extruded aluminum alloy
Processor	CPU	Intel® Celeron® J6412 2.0 GHz (up to 2.6 GHz, quad-core, TDP 10W)
	Chipset	SoC
Memory	System Memory	1 x SO-DIMM DDR4 3200 (8GB pre-installed) (up to 32GB)
Storage	Hard Drive	1 x 2.5" SATA 6Gb/s HDD/SSD bay
	eMMC	1 x eMMC 5.1 (optional)*
I/O Interfaces	USB	4 x USB 3.2 Gen2
	Ethernet	2 x 2.5 GbE by Intel® I225-V/I226-V controller
	Display	2 x HDMI™ (up to 4K@30Hz)
	COM	4 x RS-232/422/485 (DB-9)
	Digital I/O	8-bit Digital I/O (4-in/ 4-out)
	CAN BUS	2 x CAN-bus (DB9 with 2.5kV isolation)
	Wireless	1 x 802.11a/b/g/n/ac (optional)
	TPM 2.0	1 x TPM (2 x10 pin) Intel PTT
	Others	1 x Power Button, 1 x Reset Button, 1 x AT/ATX Switch, 1 x LED for Power (Green), 1 x LED for HDD (Yellow)
Expansions	M.2	1 x M.2 A Key 2230 (PCIe Gen3 x1/USB 2.0) 1 x M.2 M Key 2280 (PCIe Gen3 x2)
	Power Input	3-pin terminal block: 12-24V DC
Power	Remote Power	Terminal Block: 2-Pin
	Power Consumption	+12V @ 3.36A (Intel® Celeron® J6412 with 8GB memory)
	Mounting	DIN-Rail, Wall Mount
Reliability	Operating Temperature	-20°C ~ 60°C with 0.7M/S air flow (M.2), 10% ~ 95%, non-condensing
	Storage Temperature	-20°C ~ 70°C, 10% ~ 90%, non-condensing
	Operating Shock	Half-sine wave shock 5G, 11ms, 100 shocks per axis (SSD)
	Operation Vibration	MIL-STD-810G 514.6C-1 (SSD)
	Weight (Net/Gross)	1.39 /1.68 kg
	Safety / EMC	CE/ FCC/ UKCA
	Watchdog Timer	Programmable 1~255 sec/min
	OS	Supported OS

* Based on project discussion, it might have MOQ criteria. Please contact with Sales Account.

Fully Integrated I/O

Top View

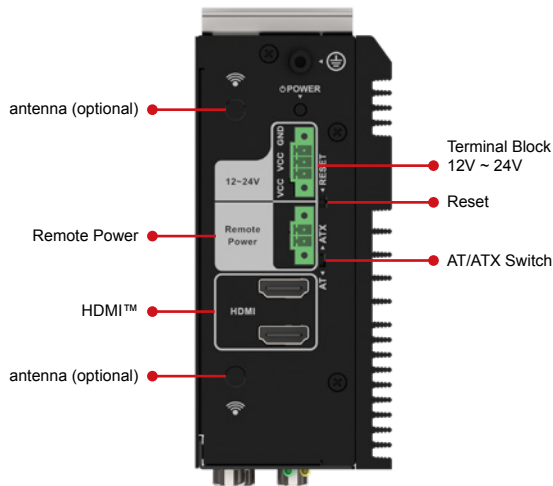

Front View

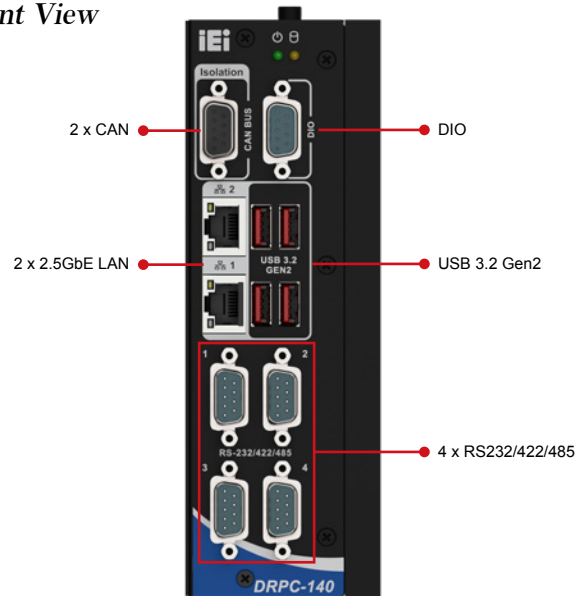

Dimensions (Unit: mm)

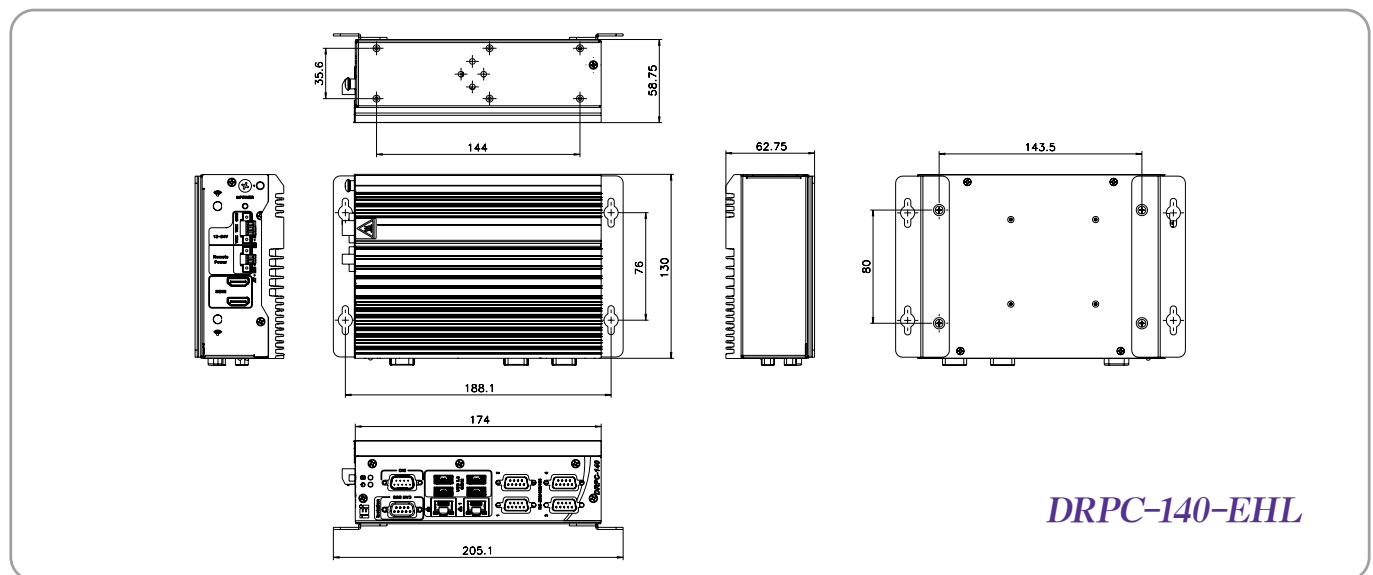

Ordering Information

Part No.	Description
DRPC-140-EHL-JC-R10	Fanless embedded system, Intel® Celeron® J6412 2.0GHz, (up to 2.6GHz, 4-Core, TDP 10W), 8GB DDR4 pre-installed memory, 4 x RS-232/422/485, 4 x USB 3.2, 2 x HDMI™, 2 x 2.5GbE Lan, 8-bit DIO, 2 x CAN-Bus, 12~24V DC and RoHS

Options

Item	Part No.	Description
WIFI Module	EMB-WIFI-KIT02I3-R10	2T2R M.2 wifi module kit for embedded system, IEEE802.11a/b/g/n/ac/ax, 1 x M.2 AE Key Wireless LAN & Bluetooth 5.2; Intel; AX210.NGWG Module, 2 x RF cable, 2 x Antenna; RoHS
DC Power Cable	32102-042300-100-RS	POWER CABLE; 200MM; (A)DC JACK 5.5X2.5, NUT+WASHER; (B)TERMINAL BLOCK:3P P=3.5
Power Adapter	63040-430084-000-RS	Adapter Power; Huntkey; HKA09012070-7U; P11-090128801R; Active PFC; Vin:100~240VAC; 84W; Dim:138*51*30.1mm; Plug=10mm; Cable=1200mm; Vout:12VDC
Power Cord	32702-000202-100-RS	POWER CORD; EUROPEAN CODE(VDE); 1000mm; 300V; (A)PLUG:SH-005(16A/250V); (B)CONNECTOR:C13(SH-006, 10A/250V)
TPM Module	TPM-IN03-R10	20-pin Infineon SPI TPM2.0 module, software mangement tool
Wall Mount Kit	41420-0583C2-00-HF*	WALL MOUNT BRACKET; NCT processing formation; DRPC-140-EHL; Powder Painting; PMS Black C
OS	DRPC-140-EHL-W10IoT21-E-R10	OS Image with Windows® 10 Enterprise Entry 64-bit 2021 LTSC for DRPC-140-EHL Series, with DVD-ROM, RoHS

*Wall Mount Bracket quantity required 2

Packing List

1 x DIN-Rail mounting kit	1 x Screw pack
---------------------------	----------------